

DRUM EQUIPMENT • HAND TRUCKS • LIFT EQUIPMENT • PLATFORM TRUCKS & CARTS • RELATED PRODUCTS

# WESCO®

## Industrial Products, Inc.



Manufacturers of Material Handling Equipment Since 1948

## Drum Handling Equipment



## Hand Trucks



## Lift Equipment



## Platform Trucks and Carts



## Dock and Shipping Equipment, Wire Shelving and Wheels





# TABLE OF CONTENTS

## Drum Handling Equipment

Drum Trucks, Pail Truck.....	4 - 8
Hydraulic Drum Handlers .....	9 - 10
Dollies .....	<i>New Product Page 11</i> .....10 - 11
Drum Dispensers, Racks & Cradles .....	<i>New Product Page 12</i> .....12 - 13
Drum Lifters & Dispensers Used With Hoists .....	<i>New Product Page 15</i> .....14 - 15
Fork Truck Mounted Drum Grabs & Dispenser .....	<i>New Product Page 18</i> .....16 - 19
Drum Faucets, Valves, Vents, Gauges, Wires .....	20 - 21
Drum Wrenches, Manual Deheaders, Pumps.....	22 - 23

## Hand Trucks

Industrial Duty Deluxe Steel, Convertible .....	<i>New Product Page 27</i> .....24 - 27
Standard Duty Greenline Steel, Convertible .....	<i>New Product Page 28</i> .....27 - 30
Touch-N-Tilt, Freight King, Specialty, Heavy Duty, Economy, High Frame .....	<i>New Product Page 34</i> .....31 - 36
Mighty-Lite Magnesium, Cobra-Lite Aluminum, Cobra Convertible, 3 Position Truck, Spartan Convertible .....	<i>New Product Page 44</i> .....37 - 49
<i>Facts About Diabetes and JDRF</i> .....	45
Steel & Magnesium Appliance & Vending, Powered Appliance Truck .....	<i>New Product Page 53</i> .....50 - 54

## Lift Equipment

Pallet Trucks, Manual & Battery .....	<i>New Product Pages 55, 56, 58, 59 &amp; 60</i> .....55 - 61
Steel & Magnesium Pedalifts, Lite Lifts, Universal & Cylinder Lifts .....	<i>New Product Page 64</i> .....62 - 65
Stackers & Lift Tables, Manual & Powered ....	<i>New Product Pages 68, 69, 70, 71, 72, 74, 75 &amp; 76</i> ..66 - 76
Gantry Cranes, Chain Hoists, Trolleys .....	77 - 78
Rais-N-Rol Machinery Movers, Furniture Movers .....	<i>New Product Page 81</i> .....79 - 81

## Platform Trucks, Carts & Dollies

Aluminum Platform Truck.....	82
Steel & Wood Platform Truck, Steel Service Carts, Panel Carts .....	<i>New Product Pages 83, 84 &amp; 85</i> .....83 - 85
Folding Handle Platform, Telefolding, Office Caddy, Desk Mover .....	<i>New Product Page 86</i> .....86 - 87
Superlite, Wire Office Carts.....	88
Steel Deck & HeviMover Machinery Movers, Wood Dollies, Plastic Box Trucks .....	89 - 90

## Dock and Shipping Equipment, Wire Shelving

Strapping Truck, Cutters, Strapping Tools.....	91
Easy Mount Strip Doors, Dock Lights, Fans, Pallet Pullers, Curb Ramp .....	92 - 93
Chrome Plated Wire Shelving .....	94 - 95
Trailer Stabilizing Jacks & Cargo Bars .....	<i>New Product Page 96</i> .....96
Wheels .....	97 - 98

# Wesco® drum trucks

## Drum truck features:

- Industrial strength heavy duty 1" structural pipe frames.
- All joints double welded.
- High quality cast iron center moldon rubber wheel with 1" (ID) roller bearings.
- Polyolefin wheel is cost competitive and resistant to most environments that may damage rubber wheels.
- All trucks can be stored standing upright.
- Engineered to handle 55 gallon steel drums.
- Capacity: 1,000 lbs.

### 5BT & 5BTW economy series

#### Features:

- Sturdy dual pipe frame.
- Economical angular steel base design.
- Kickstand
- Vinyl handle grips.
- 24" wide at handle.
- 16.25" at nose.
- With wheels resting on floor, 24" to center of lowered chime hook.

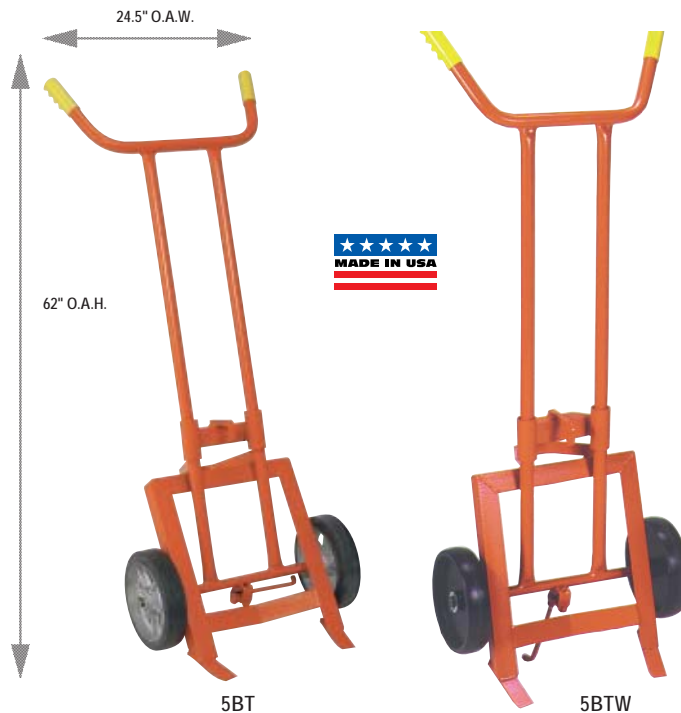

### Wheel Choices

	10" x 2.5" Moldon Rubber	10" x 2.25" Polyolefin
Part #	240009	240010
Model #	5BT	5BTW
Capacity	1,000 lbs	1,000 lbs
Weight	68 lbs	53 lbs

### 10BT & 10BTW standard series

#### Features:

- Machined steel load wheels behind nose prongs help ease the lifting of the drum.
- Classic single bar frame design.
- Kickstand.
- Vinyl handle grips.
- 24" wide at handle.
- 16.25" at nose.
- With wheels resting on floor, 24" to center of lowered chime hook.

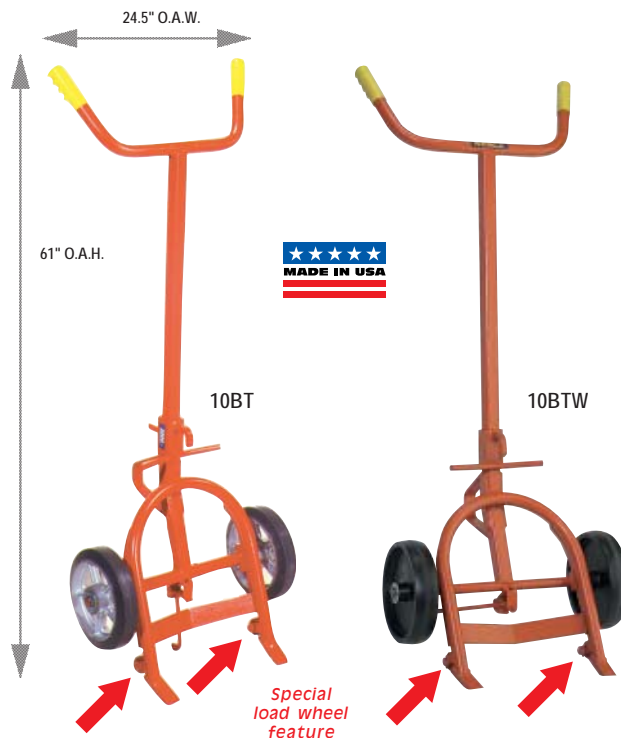

	10" x 2.5" Moldon Rubber	10" x 2.25" Polyolefin
Part #	240013	240014
Model #	10BT	10BTW
Capacity	1,000 lbs	1,000 lbs
Weight	64 lbs	50 lbs

## 15BT and 15BTW deluxe series

### Features:

- Four wheel design enables user to quickly and easily load and unload drums from pallet.
- Rear 6" wheels stabilize load for effortless transport.
  - Cast iron center moldon rubber front and rear wheels on 15BT.
  - Polyolefin front and rear wheels on 15BTW.
- Replaceable hard faced double-beveled nose prongs.
- Self-storing chime hook.
- Kickstand.
- 16.25" at nose.
- With wheels resting on floor, 20.5" to center of lowered chime hook.



## Wheel Choices

	10" x 2.5" Moldon Rubber	10" x 2.25" Polyolefin
Part #	240001	240002
Model #	15BT	15BTW
Capacity	1,000 lbs	1,000 lbs
Weight	79 lbs	61 lbs

## 15BTC ergonomic drum truck

### Features:

- Ergonomic swivel caster design reduces operator muscle strain and fatigue.
- Swivel casters allow for smooth and tight turns in narrow work areas, such as truck beds and loading docks.
- Not recommended for loading and unloading pallets (Use 15BT above for this purpose).
- 16.25" at nose.
- Kickstand.
- Replaceable hard faced double-beveled nose prongs.
- With wheels resting on floor, 20.5" to center of lowered chime hook.



## Wheel

	10" x 2.5" Moldon Rubber
Part #	240121
Model #	15BTC
Capacity	1,000 lbs
Weight	79 lbs

# Wesco® drum trucks

## 20BT & 20BTW - deluxe series

### Features:

- An industry standard.
- Floating axle reduces effort required to break over and balance load.
- Easiest drum truck for one person to use.
- Chime hook can be stored at the top of the frame for easy use.
- Replaceable hard faced double-beveled nose prongs.
- Self-standing.
- With wheels resting on floor, 18" to center of lowered chime hook.



## Wheel Choices

10" x 2.5" Moldon Rubber



Part #  
Model #  
Capacity  
Weight

240003  
20BT  
1,000 lbs  
74 lbs

10" x 2.25" Polyolefin



240004  
20BTW  
1,000 lbs  
59 lbs

## 30BT & 30BTW - standard series

### Features:

- Multi-functional drum truck allows you to move drums on four wheels and acts as a drum cradle for storage or dispensing.
- Frame clearance for dispensing into 5 gallon pails.
- Polyolefin rollers allow for easy faucet positioning of drums.
- Rear axle allows for loading and unloading of drums from pallets.
- Kickstand.
- 16.5" drain height.
- With wheels resting on floor, 27" to center of lowered chime hook.

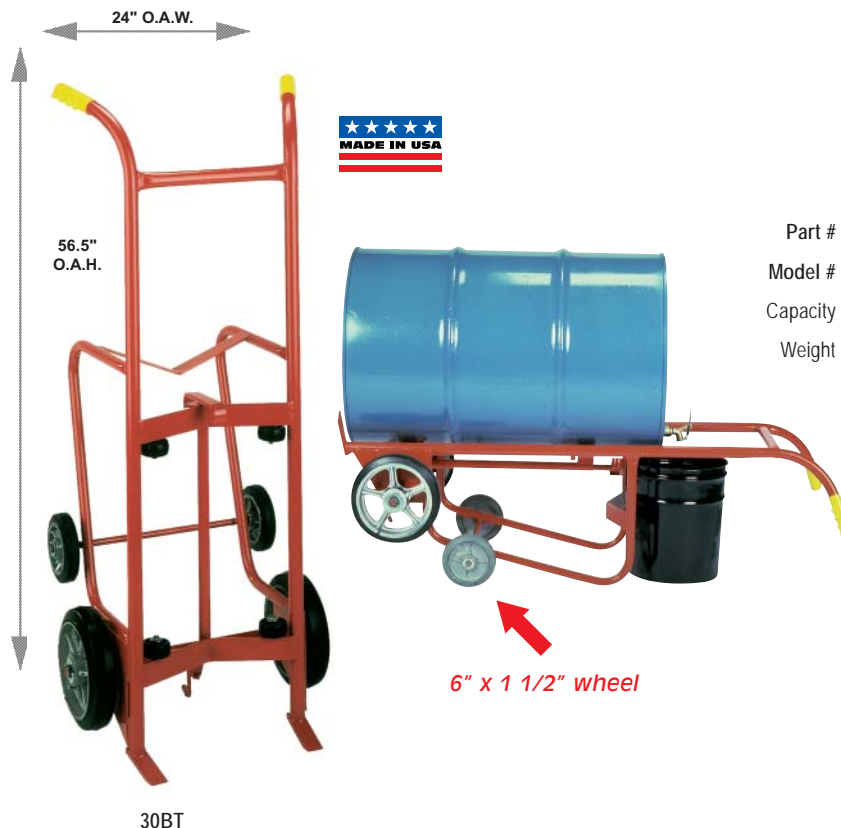

## Wheel Choices

10" x 2.5" Moldon Rubber



Part #  
Model #  
Capacity  
Weight

240005  
30BT  
1,000 lbs  
82 lbs

10" x 2.25" Polyolefin



240006  
30BTW  
1,000 lbs  
66 lbs

6" x 1 1/2" wheel



# Wesco® patented poly drum trucks

PATENT NO. 344,833

## 40BT and 40BTW series

### Features:

- Handles all poly and fiber drums except overpacks (use 45BT for overpacks).
- Replaceable "feet" and belt.
- Floating axle reduces effort required to break over and balance load.
- 23.5" depth
- With wheels resting on floor, 27" to center of belt.



Patented Design

## Wheel Choices

10" x 2.5" Moldon Rubber



Part # 240081  
Model # 40BT  
Capacity 1,000 lbs  
Weight 82 lbs

10" x 2.25" Polyolefin



Part # 240076  
Model # 40BTW  
Capacity 1,000 lbs  
Weight 67 lbs

## 45BT and 45BTW series

### Features:

- Long belt allows truck to handle all poly drums.
- Recommended primarily for handling of overpacks.
- Replaceable "feet" and belt.
- Floating axle reduces effort required to break over and balance load.
- 23.5" depth.
- With wheels resting on floor, 27" to center of belt.



Patented Design

10" x 2.5" Moldon Rubber



Part # 240082  
Model # 45BT  
Capacity 1,000 lbs  
Weight 82 lbs

10" x 2.25" Polyolefin



Part # 240077  
Model # 45BTW  
Capacity 1,000 lbs  
Weight 67 lbs

## 50BT and 50BTW series

### Features:

- Acts as a Poly Drum Truck or Drain Stand.
- Wide "feet" and belt eliminate the risk of drums being punctured by nose prongs and chime hooks.
- Handles all poly drums (except overpacks).
- 6" x 1.5" rear wheel.
- With wheels resting on floor, 27" to center of belt.



Patented Design

10" x 2.5" Moldon Rubber



Part # 240083  
Model # 50BT  
Capacity 1,000 lbs  
Weight 86 lbs

10" x 2.25" Polyolefin



Part # 240078  
Model # 50BTW  
Capacity 1,000 lbs  
Weight 65 lbs

Rear wheels on 50BT - Aluminum Ctr. moldon rubber  
Rear wheels on 50BTW - Polyolefin

# Wesco® drum trucks

## 156DH combination drum and hand truck

### Features:

- Up to 800 lb. capacity.
- Can be used as a hand truck or drum truck.
- Chime hook works with 55- and 30-gallon drums.
- Curved frame accommodates 5-gallon pails and kegs.
- 15" depth.
- With noseplate resting flat on floor, 18" to center of lowered chime hook.



## Wheel Choices

10" x 2.75"  
Semi-Pneumatic



Part # 210340

Model # 156DH-Z

Capacity 700 lbs

Weight 39 lbs

Axle .625"

Bearing Ball Bearing

8" x 2"  
Moldon Rubber



Part # 210349

Model # 156DH-HB

Capacity 800 lbs

Weight 42.5 lbs

Axle .75"

Bearing Roller Bearing

10" x 3.5"  
Pneumatic



Part # 210266

Model # 156DH-P

Capacity 700 lbs

Weight 42 lbs

Axle .625"

Bearing Ball Bearing

## PT pail truck

### Features:

- Handles up to four standard steel or plastic 5-gallon pails.
- Ergonomic design eliminates the need to stack pails on a noseplate.
- 10" semi-pneumatic wheels.
- Welded frame construction.



10" x 2.75"  
Semi-Pneumatic



Part # 240042

Model # PT

Capacity 500 lbs

Weight 40 lbs



# Wesco® drum handlers

## Features:

- Patented design. US No. 6,619,905
- Designed for a firm grip. Exclusive patented auto grip lock will not drop a drum.
- 1,100 lb. capacity.

## DM-1100 ergonomic drum handler

### Features:

- Patented design.
- 1,100 lb. capacity.
- Ergonomic solution for lifting, transporting, and placing drums on spill pallets or standard pallets.
- No need for the operator to touch the drum to raise, transport, and lower.
- 1,100 lb capacity hydraulic jack for easy lifting of steel, poly and fiber drums.
- Spring loaded clamp holds any 3/16" or higher drum rim.
- Ergonomic design allows 55 gallon drums to be easily raised 20" above the floor.
- Swivel casters for easy movement and steering.
- Floor lock.
- Handles most standard 30, 55, and 85 gallon drums.



Revolutionary patented design available only from Wesco. Wesco's exclusive auto grip lock automatically locks the grip jaws closed. Even over rough terrain, the Wesco **Gator Grip** maintains a positive lock. Why take chances with other brands when you can be sure with the Wesco **Gator Grip**.



Part #	Model #
240150	DM-1100

## Specifications

Weight: 355.5 lbs  
 Lift Height: 20 inches  
 Rise/stroke: 1 inch  
 Height: 48 inches

Legs extended:  
 Capacity: 1,100 lbs  
 Length: 37 inches  
 Width: 41 inches

Legs retracted:  
 Capacity: 650 lbs  
 Length: 34.5 inches  
 Width: 36 inches

Casters:  
 5" x 2" Phenolic caster

Patented Gator Grip  
 No. 6,619,905

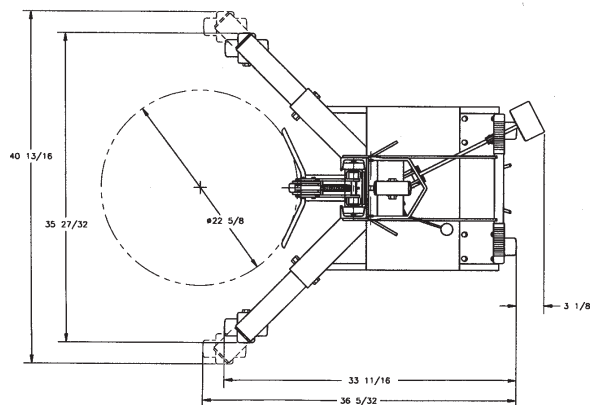
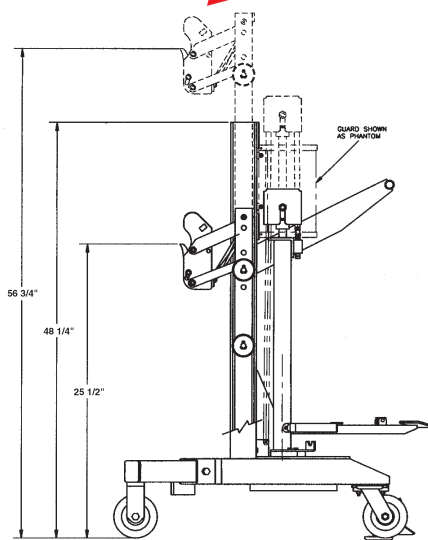

# Wesco® drum trucks & stackers

## Wesco hydraulic drum stackers

### Features:

- Phenolic 5" diameter front wheels and 4" rear phenolic swivel casters.
- Floor lock and safety screen are standard.
- 1,000 lb capacity.
- Lowers drums to the floor.
- Base leg span 42" inside, 48.75" outside.



ESFL-56-DS

Part #	260056	260057	260058
Model #	ESFL-56-DS	ESFL-64-DS	ESFL-76-DS
Lift Height	56"	64"	76"
Overall Height	72"	80"	92"
Weight	295 lbs	314 lbs	327 lbs
Capacity	1,000 lbs	1,000 lbs	1,000 lbs

## Spill-Less open drum truck

### Features:

- Transport drums in a vertical position.
- Handles 55 gallon drums.
- Heavy duty 5" x 2" polyolefin caster with roller bearings.
- All welded construction.



500

Part #	240015
Model #	500
Capacity	1,000 lbs
Weight	70 lbs
Load Wheels	Two 8" x 2" Moldon Rubber with Roller Bearings



# Wesco® drum dollies

## Drum dollies

### Features:

- Superior design places drum chime over caster kingpin for greater load stability and long caster life.
- All welded steel frame construction with reinforced outriggers.
- Four bolt on 3" swivel casters.
- I.D. varies among models.
- Models available for 30, 55, and 85 gallon drums.

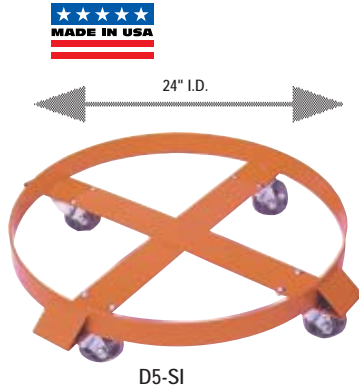

	Sintered Iron Casters	Hard Rubber
Part #	240028	240029
Model #	D3-SI	D3-HR
Capacity	1,000 lbs	900 lbs
Weight	19 lbs	16 lbs
Unit I.D.	19"	19"
Drum size	30 gal.	30 gal.
Part #	240030	240031
Model #	D5-SI	D5-HR
Capacity	1,000 lbs	900 lbs
Weight	22 lbs	19 lbs
Unit I.D.	24"	24"
Drum size	55 gal.	55 gal.
Part #	240088	240089
Model #	D8-SI	D8-HR
Capacity	1,000 lbs	900 lbs
Weight	26 lbs	23 lbs
Unit I.D.	27"	27"
Drum size	85 gal.	85 gal.

# Wesco® specialty dollies

## Specialty dollies

### Features:

- 3" x 1 1/4" polyolefin caster.
- Steel or aluminum designs.

\*Model SSD with drain plug and handle.



Part #	240033	240040	240043	240044
Model #	RSD	*SSD	RASD	RAOD
Capacity	900 lbs	900 lbs	900 lbs	900 lbs
Weight	22 lbs	47 lbs	20 lbs	14 lbs
Unit I.D.	24" dia.	23.625" sq.	24" dia.	24" dia.
Drum size	55 gal.	up to 55 gal.	up to 55 gal.	55 gal.
Caster	2 Rdg./2 Swvl.	4 Swivel	4 Swivel	4 Swivel
Material	Steel	Steel	Aluminum	Aluminum



RSD



SSD



RASD



RAOD



# Wesco® drum dispenser & racks

## Drum carrier and dispenser

### Features:

- Lift, transport, tilt, and dispense 55 gallon steel drums.
- Three height adjustments: 9.25", 10.625", and 12".
- Locks vertically or horizontally.
- Ships partially assembled and boxed.
- Heavy duty polyolefin load wheels and caster.
- 37" deep.
- Options include: 30 gallon drum adapter and fiber drum adapter.
- 8" x 2" wheels and 4" x 1 1/4" caster.

## Value drum carrier and dispenser

### Features:

- Economically priced.
- Three height adjustments: 9.25", 10.625" and 12".
- Vertical and horizontal locking positions.
- Ships KD.
- Polyurethane wheels and casters.
- 8" x 2" wheels and 4" x 1 1/4" caster.

## Wesco drum racks

### Features:

- Two and three 55 gal. drum models.
- Four-side fork truck entry.
- Can be safely stacked 4 high.
- Standard models ship knocked down and boxed via UPS.
- Quick and easy to assemble.
- Welded and bolted construction.



Part #	240037
Model #	ML-55
Capacity (full drum)	800 lbs
(half full drum)	500 lbs
Weight	105 lbs
<b>30 Gallon Drum Adapter</b>	
Part #	270040
Model #	DMG-30A
Weight	24 lbs
<b>Fiber Drum Adapter</b>	
Part #	270402
Model #	FBA
Weight	3 lbs



Part #	272404
Model #	VDCD
Capacity (full drum)	800 lbs
(half full drum)	500 lbs
Weight	108 lbs

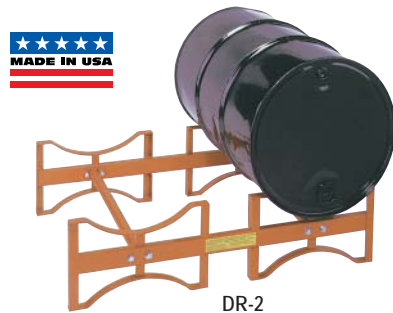

Part #	240026
Model #	DR-2
Capacity	1,600 lbs
Drums	2
Dimensions	45.5" x 30" x 12.5"
Weight	49 lbs

240027
DR-3
2,400 lbs
3
71.5" x 30" x 12.5"
75 lbs

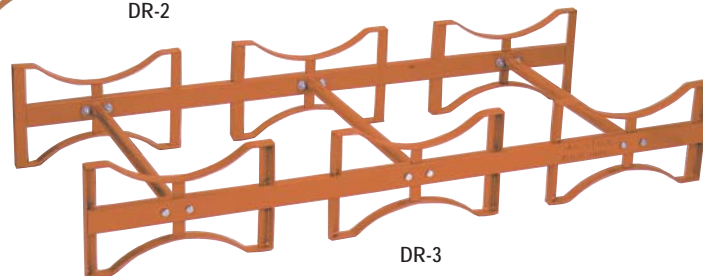

## Deluxe drum cradle

### Features:

- Tips, drains, stores, rotates and moves 30 or 55 gallon steel and fiber drums.
- Dual telescoping wood handles allow easy two handed control and offer a good gripping surface for cold weather usage.
- Large 4" x 1.25" polyolefin wheels for easy movement over uneven floors.
- Shipped knocked down and boxed via UPS.
- Covered by U.S. patent 4,335,990.
- Backed by 2 year warranty against weld failure.
- Drip tray option.



CW-20

### Specifications

- 20" drain height
- 25.5" overall height
- 19" wide

Part #	Model #	Capacity	Weight
240025	CW-20	1,000 lbs	50 lbs

Drip tray option available.

## Standard drum cradles

### Features:

- Economical and convenient way to tip, drain and store 55 gallon drums.
- Easy for one person to use.
- All models ship knocked down and boxed via UPS.
- Models available with 2.5" polyolefin wheels, self-storing load tipping lever, and swivel casters.
- Drip tray option available for all models



CW-10  
(wheels inside frame)



CWO-10  
(wheels outside frame)



CWS-10  
(two swivel casters)

### Specifications

All models 32.5" long by 19.5" wide.

Drum distance to floor on wheeled models is 15".

Drum distance to floor on models without wheels is 13.5".

Part #	Model #	Wheel Position (Polyolefin)	Tipping Lever	Capacity	Weight
240021	C-10	No Wheels	Yes	600 lbs	27 lbs
240022	CW-10	Inboard	Yes	600 lbs	29 lbs
240023	CWO-10	Outboard	Yes	600 lbs	32 lbs
240024	CWS-10	Inboard, 2 swivel casters	Yes	600 lbs	37 lbs

## Drip tray

### Features:

- Steel slide-out tray 9.75" x 9.75" with 1.75" lip.
- Fits all Wesco drum cradles.
- Polyethylene pan
- Cellulose absorbent holds 3 quarts of liquid.

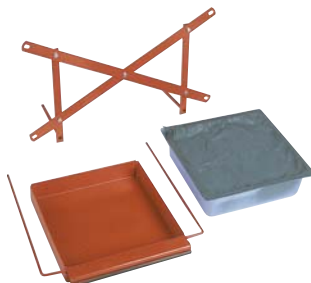

Drip tray kit with plastic absorbent pan  
Model # DT Weight  
Part # 270413 7.5 lbs

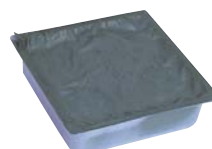

Replacement plastic absorbent pan (disposable)  
Part # 270414



CW-10 with optional drip tray

# Wesco® drum lifters for hoists

## Vertical drum lifter

### Features:

- Picks up and sets down drums automatically.
- Ships assembled and boxed.
- Simple-to-set latch controls.
- After releasing drum the grab remains open for next drum.
- For use with sealed open-head or tight-head 55 gallon steel drums.



DL-1

Part #	240036
Model #	DL-1
Capacity	1,000 lbs
Weight	51 lbs

## Salvage drum lifters

### Features:

- Convenient for fast and gentle loading of steel drums into overpacks.
- Ships boxed via UPS.
- For use with closed head steel drums.



SDL-55

SDL-85

	For 55 Gal. Drums	For 55 or 85 Gal. Drums
Part #	240100	240102
Model #	SDL-55	SDL-85
Capacity	1,000 lbs	1,000 lbs
Weight	20 lbs	21 lbs

## Economy drum lifter

### Features:

- Lightweight and easy to use.
- Lock pin design holds drum firmly in place.
- Ships boxed via UPS.
- For use with closed head 55 gallon steel drums.



EDL-5

Part #	240057
Model #	EDL-5
Capacity	700 lbs
Weight	15 lbs



# Wesco® drum lifters for hoists

## Standard drum lifter/dispenser

### Features:

- Easily lift drum and dispense contents.
- Handles 55 gallon steel drums.
- Locks in horizontal or vertical position.
- Ships assembled and boxed.
- See options below.
- Economical, lower capacity VALUE product also available.

## Deluxe drum lifter/dispenser

### Features:

- Geared design for controlled dumping from many heights and angles.
- Locking control chain to secure drum from turning.
- Ships assembled and boxed.
- See options below.
- Economical, lower capacity VALUE product also available.

## Options

- DMG-30A for use with 30 gallon drums, and FBA for use with fiber drums. For use with DL and DGL-55 models only.

## Hoist mount drum lifter

### Features:

- Heavy duty annealed ductile iron.
- Curved foot on stabilizing arm prevents damage to drum.

## Slings

### Features:

- Horizontally lift all "closed or open-head" drums.
- D-shaped lifting ring fits most overhead systems.
- Inverted ring fits web-lifting slings.

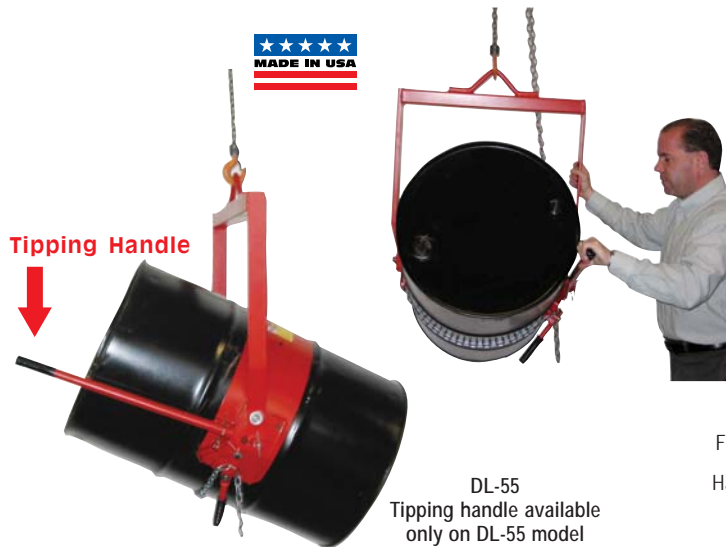

**New!**



Value, VDL-55

Part #	240032	278750
Model #	DL-55	VDL-55
Full Drum Capacity	800 lbs	700 lbs
Half Drum Capacity	500 lbs	440 lbs
Weight	45 lbs	44 lbs



**New!**



Value, VDGL-55

Part #	240034	278751
Model #	DGL-55	VDGL-55
Full Drum Capacity	800 lbs	700 lbs
Half Drum Capacity	500 lbs	440 lbs
Weight	70 lbs	84 lbs

Part #	270402	270040
Model #	FBA	DMG-30A
Weight	3 lbs	24 lbs



Part #	440001
Model #	DRL-3
Capacity	3,000 lbs
Weight	31 lbs

Part #	440009
Model #	DLS-1000
Capacity	1,000 lbs
Weight	5 lbs

Part #	440010
Model #	DLS-750
Capacity	750 lbs
Weight	5.25 lbs

# Wesco® drum grabs for use with fork trucks

## Gator Grip

Patented design No. 6,619,905



Traditional devices require drum weight to maintain a positive Lock. If a drum bounces during Fork Truck transportation, the drum may momentarily become weightless, which can cause the Grip to snap open dropping the drum. The patented auto grip Lock automatically Locks the jaws closed even over rough terrain.

STEEL



FIBER



POLY



### Features:

- **Patented design.**
- Picks up drums automatically, driver never leaves seat while lifting and releasing drums.
- Use with open or closed head drums.
- Handles steel, fiber and poly drums.
- Gator Grips made in USA.
- Both single and dual grip products available.
- Economy and Heavy Duty models.
- Optional Gator Belt protects drum from wear. Not available on EGG models.

### Economy Gator Grip - 1000 lb. cap. per Grip



EGG-1



EGG-2

### Heavy Duty Gator Grip - 1600 lb. cap. per Grip



#240093 Carriage Mount  
Model GG-C



#240096 Single Drum Fork  
Mount Model GG-F1



#240097 Dual Drum Fork Mount  
Model GG-F2



Power Stacker Mount  
#240103 Model GGPS



#240107  
Gator Belt Option  
Model GGBK



Style	Part #	Model #	Capacity per Grip	ID	Weight	Overall Dimensions		
						H	W	D
Economy Single Drum	240091	EGG-1	1,000 lbs	5.5" x 2"	126 lbs	34"	28"	34"
Economy Dual Drum	240092	EGG-2	1,000 lbs	7" x 2.25"	208 lbs	34"	33.25"	34"
Carriage Mount	240093	GG-C	1600lbs	NA	96lbs	33.25"	15.625"	18"
Single Drum/Fork	240096	GG-F1	1600lbs	7" x 2.25"	244lbs	37"	32"	28"
Dual Drum/Fork	240097	GG-F2	1600lbs	7" x 2.25"	340lbs	37"	32"	28"
Stacker Mount	240103	GGPS	1600lbs	NA	96lbs	33.25"	18"	17"
Belt Option	240107	GGBK	NA	NA	4lbs	3"	18.5"	

Note: OSHA requires contacting the manufacturer of your fork truck for written approval for the use of any fork truck attachments.

# Wesco® drum grabs for use with fork trucks

## Drum grabs for 55 gallon steel drums

### Features:

- All welded steel construction for durability.
- Cost effective way to move 55 gallon steel drums.
- Made in USA.

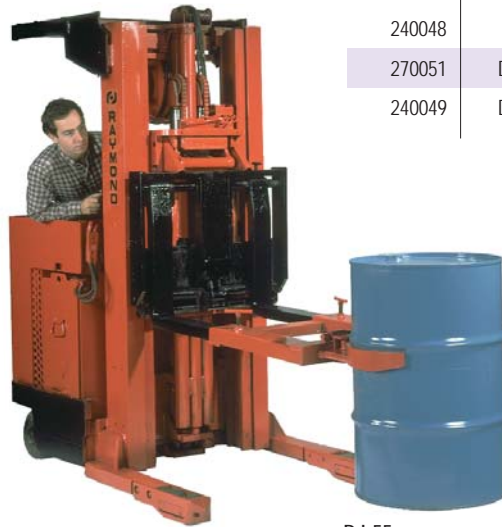

DJ-55

Part #	Model #	Capacity	Handles	Fork Pocket ID	Weight
240048	DJ-55	1,500 lbs/drum	one 55 gallon	5.5" x 2"	145 lbs
270051	DJL-55	1,500 lbs/drum	one 55 gallon	7" x 2.25"	150 lbs
240049	DJ-255	1,500 lbs/drum	two 55 gallon	7" x 2.25"	205 lbs

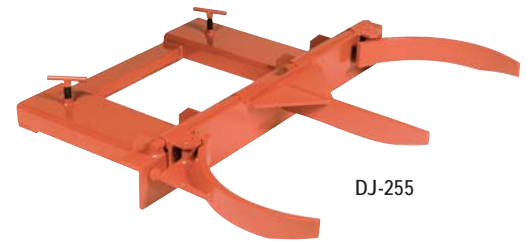

DJ-255

## Adjustable drum grabs for 55 or 30 gallon steel drums

### Features:

- ADJ models feature all welded steel construction for durability.
- ADJ models are made in the USA.
- All ADJ and DRL units handle 55 or 30 gallon steel drums.
- DRL models have cast arms that are replaceable.
- Cost effective way to move 55 and/or 30 gallon drums.



ADJ-53  
30 gallon position



DJ-55  
55 gallon position



DRL-DT



DRL-2DT-W30

Part #	Model #	Capacity	Handles	Fork Pocket ID	Weight
240047	ADJ-53	1,500 lbs/drum	1-55 gal. or 1-30 gal.	5.5" x 2"	135 lbs
270084	ADJL-53	1,500 lbs/drum	1-55 gal. or 1-30 gal.	7" x 2.25"	135 lbs
240066	ADJ-253	1,500 lbs/drum	2-55 gal. or 2-30 gal.	7" x 2.25"	215 lbs
340002	DRL-DT	1,500 lbs/drum	1-55 gal. or 1-30 gal.	5.5" x 2.5"	130 lbs
340001	DRL-2DT-W30	1,500 lbs total	1-55 or 1-30; 2-55 or 2-30; 1-55 and 1-30	5.5" x 2.5"	163.5 lbs



# Wesco® value drum equipment

## Value drum grabs

### Features:

- Economically priced lower capacity grabs
- VG models: jaws not adjustable
- AVG models: adjustable jaws



Part #	Model #	Capacity	Handles	Pocket ID	Weight
272400	SVG-55	1,000 lbs/drum	1-55 gal.	5.5" x 2"	121 lbs
272401	DVG-255	1,000 lbs/drum	2-55 gal.	7" x 2.25"	198 lbs
272408	SAVG-53	1,000 lbs/drum	1-55 gal. or 1-30 gal.	5.5" x 2"	115 lbs
272409	DAVG-253	1,000 lbs/drum	2-55 gal. or 2-30 gal.	7" x 2.5"	194 lbs

## Value fork truck drum lifter & tilter

### Features:

- Economically priced lower capacity model.
- Two models, 700 & 1,400 lb capacities.
- Operator does not have to leave seat to tilt drum.

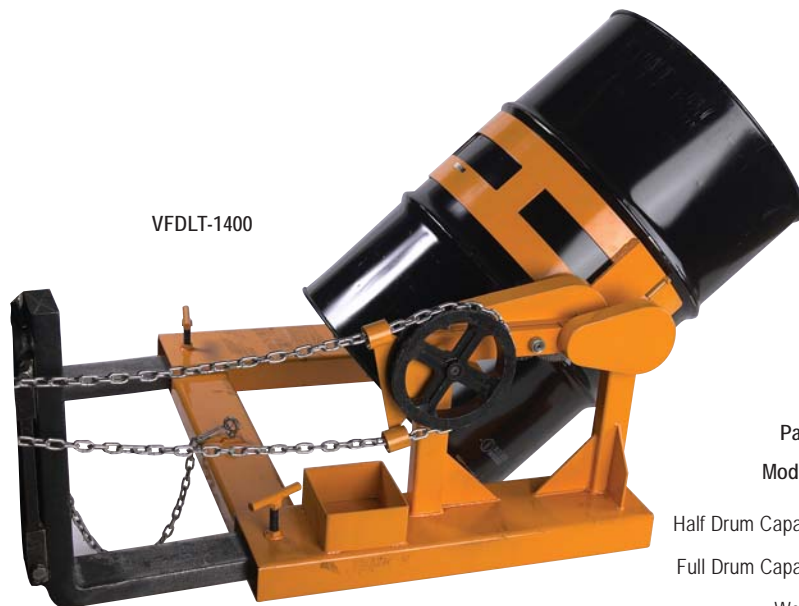

	Part # 272402	272403
Model #	VFDLT-700	VFDLT-1400
Half Drum Capacity	440 lbs	750 lbs
Full Drum Capacity	700 lbs	1400 lbs
Weight	154 lbs	214 lbs

# Wesco® drum grab & dispenser for fork trucks

## Fork truck drum lifter & tilter DGF-55

### Features:

- Fork truck driver does not have to leave truck to dispense.
- Offers versatile drum dispensing capabilities that do not require hoists.
- Geared design allows controlled dumping and dispensing.
- Does not require any modifications to the fork truck.
- Ships assembled and boxed.
- Has 800 lbs capacity for a full drum, 500 lbs for a half full drum.
- Adapters available for 30 gallon and fiber drums.



DGF-55



### Specifications

20.5" high x 38" wide x 32.5" deep  
 Fork pocket dimensions (ID) 6.625" x 2.625"  
 Fork pocket dimensions center to center 31"  
 Length of Chain 144"

	55 Gallon Drum Unit	30 Gallon Drum Adapter	Fiber Drum Adapter
Part #	240039	270240	270402
Model #	DGF-55	DGF-30A	FBA
Weight	159 lbs	24 lbs	3 lbs

## Wesco polyjaws

### Features:

- Patent No. 5366339. Fork truck attachment for handling most 55 and 30 gallon poly drums.
- Fork truck driver does not have to leave cab to engage or disengage drum.
- Works on poly drums that have at least a 3/16" top lip (chime).
- 1,000 lb. capacity.
- Substantially lower priced than any other poly drum lifter on the market.
- Ships knocked down and boxed via UPS.



**PATENTED**  
**No. 5366339**



Part #	240148
Model #	PJ
Weight	37.75 lbs.

PJ

Fork Pocket Size: Inside 5.375" x 1.5"

*Note: OSHA requires contacting the manufacturer of your fork truck for written approval for the use of any fork truck attachments.*

# Wesco® FM APPROVED drum faucets & valves

## Zinc die cast faucets

### Features:

- Zinc die cast alloy.
- Easy-to-use self-closing design.
- Can be padlocked in closed position.
- .75" NPT connection.
- Viton gasket.

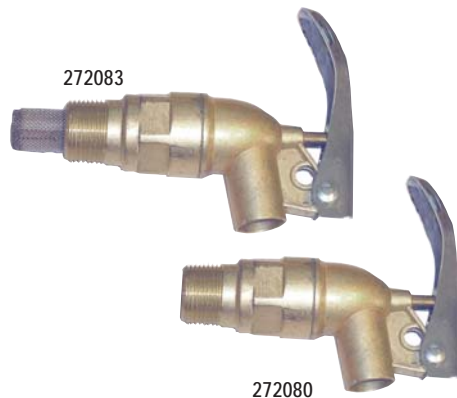

### Part# 272083

With flame arrestor.

**FM approved** for non-viscous liquids.  
*Sold only in packages of 10.*

### Part# 272080

No flame arrestor.

**FM approved** for viscous liquids only.  
*Sold only in packages of 10.*

## Heavy duty brass faucets

### Features:

- Easy-to-use self-closing design.
- .75" NPT connection.
- Teflon® gasket.

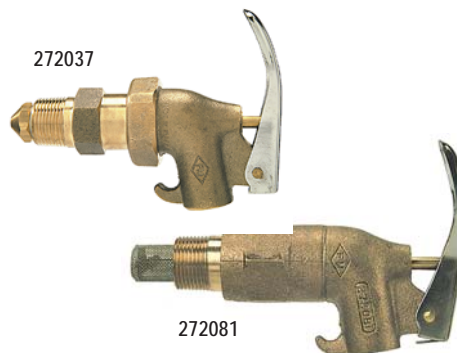

### Part# 272037

Adjustable shank designed to easily adjust to proper drain position after installing in drum.

Internal flame arrestor. **FM approved** for use with oils (under 30 SAE) and non-corrosive flammables.

*Minimum order Qty. 2.*

### Part# 272081

Rigid shank design. External flame arrestor.

**FM approved** for use with oils (under 30 SAE) and non-corrosive flammables.

*Minimum order Qty. 2.*

## Heavy duty stainless steel faucet

### Features:

- Adjustable shank designed to easily adjust to proper drain position after installing in drum.
- .75" NPT connection.
- Teflon® gasket.



### Part# 272038

Internal flame arrestor. **FM approved** for use with oils (under 30 SAE) and nonflammables, compatible with stainless steel.

## Heavy duty 2" brass gate valve

### Features:

- Fast, self-closing Teflon® blade.
- 2" NPT connection.



### Part# 272034

**FM approved** for use with viscous non-corrosive fluids heavier than 30 SAE.

Wesco recommends that if a question arises, the user contact the supplier of chemicals to determine if these faucets are compatible with those chemicals. Wesco is unable to offer specific recommendations for chemical usage.



# Wesco® drum vents, gauges & wires

## FM APPROVED vent

### Features:

- Automatically relieves pressure at 5 PSI.
- Maximum flow of 220 CFM at 20 PSI.
- Flame arrestor prevents sparks and flame from igniting drum contents.
- Fits 2" bung hole in steel and plastic drums.



### Part# 272030

For drums in horizontal (pouring) position.  
Manual vacuum relief by lifting and rotating valve stem.

**FM approved.**

*Minimum order Qty. 2.*

## Gauges

### Features:

- Economical way to gauge drum contents.
- Heavy gauge glass and plated steel construction.
- Accepts standard .75" NPT faucet.
- Buna-N seals; .75" NPT connection, 22" height (with supplied fitting).

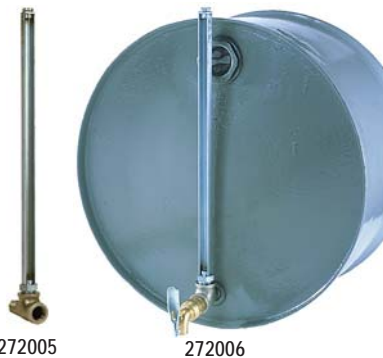

### Part# 272005

Basic gauge with fitting.

### Part# 272006

Basic gauge with fitting and 272080 faucet.

### Part# 272041

Basic gauge with fitting and 272083 faucet.

## Ground and bond wires

### Features:

- A wide variety of designs for grounding and bonding applications.



*OSHA requires that all drums and containers storing and receiving fluids with a FLASHPOINT BELOW 140°F be grounded and bonded. Single drums must be grounded, with containers being dispensed into bonded to the drum. Multiple drums must be bonded to each other with one drum or the rack grounded. The following wires allow meeting these important safety requirements.*

### Part# 272032

Deluxe Ground Wire: *For connection between drum and true ground.*

Three-foot-long heavy duty insulated wire rope with "C" clamp on one end and alligator clip on the other.

*Minimum order Qty. 5.*

### Part# 272031

All Purpose Bond Wire: *For bonding drums to each other, to containers being filled, and to racks.*

Three-foot-long heavy duty wire rope with "C" clamp on one end and alligator clip on the other.

*Minimum order Qty. 5.*

### Part# 272033

Standard Bond Wire: *For bonding drums to each other, to containers being filled, and to racks.* Three-foot-long heavy duty wire rope with alligator clips on both ends.

*Minimum order Qty. 5.*

### Part# 272047

Heavy Duty Coiled Ground Wire.

*Minimum order Qty. 5.*

# Wesco® drum wrenches & deheaders

## Deheaders

### Features:

- Open any size and gauge steel drum quickly, and easily – allowing drum recycling without the risk of fire from cutting with a torch.
- Sharp-edged hardened steel replaceable blade.
- Comfortable plastic hand grip.



Part# 272303  
Vertical slide deheader. (8 lbs.)  
Part# 272304 Replacement blade



272303



Part# 272018  
Most popular deheader. (5.5 lbs.)  
Part# 272012 Replacement blade

Part# 440013 Model DDH-1.  
Heavy duty deheader. (9 lbs.)  
Part# 440014 Model DDH-P202  
Replacement blade

## Non-sparking deheader

### Features:

- 100% non-sparking deheader. Patent No. 399.718.
- Sharp-edged hardened non ferrous alloy replaceable blade.
- Comfortable plastic hand grip.



272301

Part# 272301  
Non-sparking deheader. 100% non-sparking.  
(6.4 lbs.)  
Part# 070504  
Replacement blade

## Non-sparking drum plug wrenches

### Features:

- Bronze alloy.
- Stronger than aluminum.
- Offset handle design reduces user stress and minimizes knuckle injury.

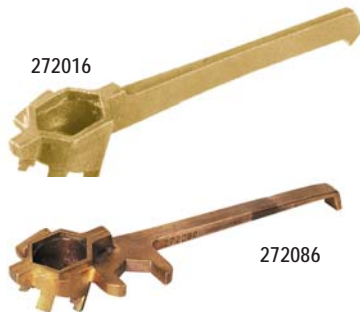

272016

272086

Part# 272016  
Our most popular wrench. Handles bung patterns 1, 2, 3, & 5.  
*Minimum order Qty. 3.*

Part# 272086  
Deluxe model. Built-in 1.25" wrench for tightening faucets into drums. Handles bung patterns 1, 2, 3, & 5.  
*Minimum order Qty. 3.*

## Universal drum plug wrench

### Features:

- Heavy duty cast iron construction.
- Open most plugs and bung nuts, male & female, steel & plastic.
- Iron alloy will not chip or bend in normal use.
- Protects knuckles.



272017

Part# 272017  
Handles bung patterns 1, 2, 3, & 4.  
*Minimum order Qty. 3.*

### Bung Patterns



## Rotary pump

### Features:

- 47" 3 piece plated suction tube (assembled).
- Durable phenolic veins.
- Self-priming.
- Supplied with 48" PVC discharge tube.
- UPS shippable.
- Rugged cast iron construction.



Rotary Pump – Cast Iron

Part# 270021  
Standard model. (15 lbs.)

Part# 272212  
Deluxe model (consists of standard model and drip pan accessory). (18 lbs.)

## Non-sparking rotary pump

### Features:

- Rugged bronze construction.
- 47" 3 piece plated suction tube (assembled).
- Durable phenolic veins.
- Self-priming.
- Supplied with 48" PVC discharge tube.
- UPS shippable.



Rotary Pump – Bronze

Part# 440017  
Bronze, non-sparking for medium viscosity petroleum-based products. Does not include drip pan. (17 lbs.)

## Lever pump

### Features:

- Pumps 1 pint per stroke.
- Rugged cast iron and steel construction.
- 47" 3 piece plated suction tube (assembled).
- Neoprene seals.
- Self-priming.
- UPS shippable.



Lever Pump

Part# 272210  
Includes drip pan. (13 lbs.)

**Application Information (For Rotary and Lever Pumps):** WESCO iron drum pumps have wetted parts fabricated from cast iron, steel, phenolic (270021 & 272212 only), and neoprene (272210 only) materials. These pumps were designed primarily for the transfer of fuel oil products. It should be noted that these pumps can only be used for chemicals which are compatible with cast iron, steel, neoprene and phenolic.

We recommend that if a question arises, the user contact the supplier of chemicals to determine if these pumps are compatible with those chemicals. WESCO is unable to offer specific recommendations for chemical usage.

## Drip pan

### Features:

- For installation on pumps with metal suction tube.
- Cast iron and steel construction.
- Hinged cover and bung/suction adapter.



Part# 272211  
Drip pan.

# Wesco® 100 series industrial hand trucks

- A 5 year guarantee against weld failure. A Wesco quality exclusive.
- Industrial strength heavy duty schedule 40 pipe frame construction.
- Ribbed cross braces for extra strength.
- All joints double welded.
- 8" deep by 14" wide nose is 7 gauge thick plate with machined beveled edge and radiused corners for safety.
- Zinc plated Auto-Loc® axles assure smooth wheel rotation.
- All frames handle 8" or 10" wheels.
- Orange enamel finish.
- Vinyl handle grips are standard on appropriate frames.
- Order by part # or model #.

Example:

Part # or Model #  
210009 or 126-R

## Wheel Choices

Hub: Dimensions: Wheel Type:	R Aluminum 8" x 1.625" Moldon Rubber	R1 Steel Offset 8" x 2.5" Semi-Pneumatic	Z Steel Offset 10" x 2.75" Semi-Pneumatic	Z2 Poly Offset 10" x 2.75" Solid Rubber	P Steel Offset 10" x 3.5" Pneumatic	PE Steel Offset 10" x 3.5" Pneumatic
						
Part #	210009	210010	210011	210380	210012	210370
Model #	126-R	126-R1	126-Z	126-Z2	126-P	126-PE
Capacity	800 lbs	500 lbs	700 lbs	800 lbs	700 lbs	700 lbs
Weight	32 lbs	38 lbs	40 lbs	40 lbs	37 lbs	34 lbs

## Series 126

### Features:

- Single pin handle curved back design allows one hand control.
- Ideal for boxes, kegs, and packages.
- Three horizontal cross straps and full height vertical center strap offer support for small packages.

As shown: 126-Z

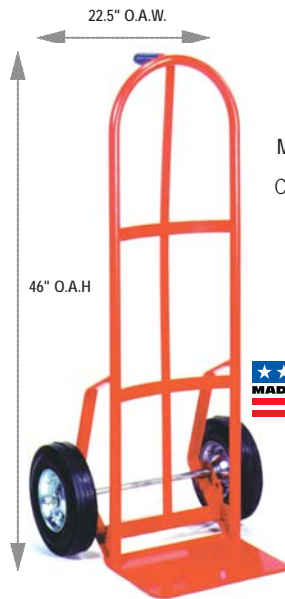

Wesco exclusive – ribbed cross straps for additional strength



## Series 126D

### Features:

- Single "D" shaped handle allows multiple hand positions for one hand control.
- Ideal for boxes, kegs, and packages.
- Three horizontal cross straps and full height vertical center strap provide support for small packages.

As shown: 126D-R1



Wesco exclusive – ribbed cross straps for additional strength





# Wesco® 100 series industrial hand trucks

## Wheel Choices

### Series 136

#### Features:

- Two handle tapered body design.
- Three heavy duty horizontal cross straps for added strength.
- Full height center strap provides support for small packages.

As shown: 136-Z

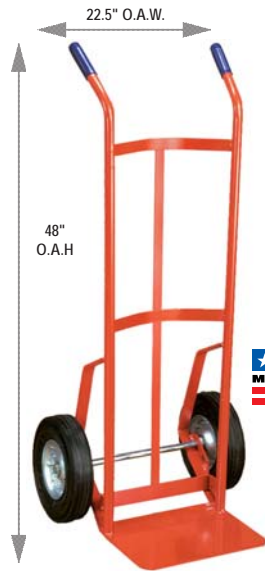

Hub:  
Dimensions:  
Wheel Type:

	R Aluminum 8" x 1.625" Moldon Rubber	R1 Steel Offset 8" x 2.5" Semi-Pneumatic	Z Steel Offset 10" x 2.75" Semi-Pneumatic	Z2 Poly Offset 10" x 2.75" Solid Rubber	P Steel Offset 10" x 3.5" Pneumatic	PE Steel Offset 10" x 3.5" Pneumatic
Part #	210024	210025	210026	210382	210027	210372
Model #	136-R	136-R1	136-Z	136-Z2	136-P	136-PE
Capacity	800 lbs	500 lbs	700 lbs	800 lbs	700 lbs	700 lbs
Weight	33 lbs	39 lbs	41 lbs	40 lbs	39 lbs	34 lbs



### Series 146

#### Features:

- Two handle extra high back curved design.
- Ideal for high loads.
- Four horizontal cross straps and vertical center strap provide support for small packages.

As shown: 146-R



Part #  
Model #  
Capacity  
Weight

Part #	210032	210033	210034	210383	210035	210373
Model #	146-R	146-R1	146-Z	146-Z2	146-P	146-PE
Capacity	800 lbs	500 lbs	700 lbs	800 lbs	700 lbs	700 lbs
Weight	34 lbs	40 lbs	42 lbs	42 lbs	39 lbs	36 lbs

Wesco exclusive – ribbed cross straps for additional strength



### Series 146D

#### Features:

- Single "D" shaped handle combined with high back curved design.
- Easier one hand control of stacked goods.
- Four horizontal cross straps and vertical center strap provide support for small packages.

As shown: 146D-R1



Part #  
Model #  
Capacity  
Weight

Part #	210038	270056	210039	210384	210040	210374
Model #	146D-R	146D-R1	146D-Z	146D-Z2	146D-P	146D-PE
Capacity	800 lbs	500 lbs	700 lbs	800 lbs	700 lbs	700 lbs
Weight	35 lbs	41 lbs	43 lbs	42 lbs	41 lbs	36 lbs

Wesco exclusive – ribbed cross straps for additional strength



# Wesco® 100 series industrial hand trucks

## Series 156

### Features:

- Swept back continuous handle with curved back design.
- Very popular frame that allows one or two hand control.
- Four horizontal cross straps and vertical center strap provide support for small packages.

As shown: 156-Z



## Wheel Choices

Hub: Dimensions: Wheel Type:	R Aluminum 8" x 1.625" Moldon Rubber	R1 Steel Offset 8" x 2.5" Semi-Pneumatic	Z Steel Offset 10" x 2.75" Semi-Pneumatic	Z2 Poly Offset 10" x 2.75" Solid Rubber	P Steel Offset 10" x 3.5" Pneumatic	PE Steel Offset 10" x 3.5" Pneumatic
Part #	210044	210045	210046	210385	210047	210375
Model #	156-R	156-R1	156-Z	156-Z2	156-P	156-PE
Capacity	800 lbs	500 lbs	700 lbs	800 lbs	700 lbs	700 lbs
Weight	31 lbs	37 lbs	39 lbs	40 lbs	36 lbs	34 lbs

Wesco exclusive – ribbed cross straps for additional strength



# Wesco® 100 series industrial hand truck options

## Nose Extension

- 24" long, 10.5" wide.
- Steel construction.



24" Nose Extension - Field Installation  
24" Nose Extension - Factory Installed

Part #	Model #
210099	FN-24K
054201	FN-24F

To order field installation simply note part # or model # on P.O.  
To order factory installed option add option part # or model # to end of industrial hand truck part or model #.

Example: 156R with 24" nose extension  
Part # 210044,054201 or Model #156-R-FN-24F

## Stairclimber

- Continuous belt.
- Replaceable parts.
- Only available on 10" wheeled models.
- Must be factory installed.



Stairclimber with Continuous Belt

Part #	Model #
270412	CBSCF

Must be factory installed.

# Wesco® two-in-one industrial steel hand trucks

## Two-In-One Deluxe Industrial Steel Hand Trucks

### Features:

- Converts easily between 2 and 4 wheel truck.
- Handle locks in horizontal and vertical positions.
- Two lengthwise straps and two cross braces prevent package fall-through.
- 3.5" or 5" Colson Hi-Tech Performa Casters—A Wesco Exclusive.
- 3/4" Schedule 40 structural pipe bed frame.

As shown:  
156-S25-Z2



53" Height  
Bed size 14" x 44.5"  
Total width 22.5"

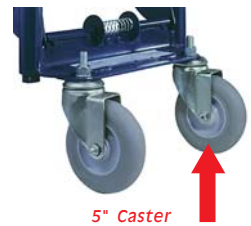

### Colson Hi-Tech Performa Casters

#### Features:

- Standard equipment on all models at no additional cost.
- Less energy required to start moving load and keep it moving.
- Performa wheels reject almost every type of floor debris, including metal shavings, chips, sand and gravel.
- Smooth, quiet ride of a soft-tread wheel.
- As durable as a hard-tread wheel.

## Wheel Choices with 3.5" Casters

	Z Steel Offset 10" x 2.75" Semi-Pneumatic	Z2 Poly Offset 10" x 2.75" Solid Rubber	P Steel Offset 10" x 3.5" Pneumatic
Hub: Dimensions: Wheel Type:			
Part #	210138	210140	210139
Model #	156-S23-Z	156-S23-Z2	156-S23-P
Weight	60.5 lbs	58.25 lbs	55.25 lbs
2 wheel capacity	700 lbs	800 lbs	700 lbs
4 wheel capacity	1,000 lbs	1,000 lbs	1,000 lbs

## Wheel Choices with 5" Casters

	Z Steel Offset 10" x 2.75" Semi-Pneumatic	Z2 Poly Offset 10" x 2.75" Solid Rubber	P Steel Offset 10" x 3.5" Pneumatic
Hub: Dimensions: Wheel Type:			
Part #	210144	210141	210143
Model #	156-S25-Z	156-S25-Z2	156-S25-P
Weight	61.5 lbs	60 lbs	56.25 lbs
2 wheel capacity	700 lbs	800 lbs	700 lbs
4 wheel capacity	1,000 lbs	1,000 lbs	1,000 lbs

5" Caster for easier rolling over rough surfaces

# Wesco® Greenline DU-ALL economy convertible two-in-one

### Features:

- Converts between 2 and 4 wheel positions.
- Capacity:  
2 wheel: 500 lbs.  
4 wheel: 600 lbs.
- Steel tubular frame construction
- 10" Semi-pneumatic wheels
- 3 1/2" Polyurethane swivel casters.
- Weight: 52 lbs.
- Ships KD, minor assembly required



Part #	210477
Model#	GDA21
Weight	52 lbs
2 Wheel Capacity	500 lbs
4 Wheel Capacity	600 lbs

# Wesco® Greenline two-in-one steel hand trucks

## Greenline economical two-in-one

### Features:



- Converts easily between 2 and 4 wheel truck.
- Double welded tubular construction.
- Lengthwise strap and cross braces prevent package fall-through.
- Solid rubber swivel casters.

### As shown:

- 2 wheel: 656-21-Q
- 4 wheel: 656-21-Z



### Wheel Choices

	Q	Z	Z2	PE
Hub:	Poly Offset	Steel Offset	Poly Offset	Steel Offset
Dimensions:	8" x 1.75"	10" x 2.75"	10" x 2.75"	10" x 3.5"
Wheel Type:	Semi-Pneumatic	Semi-Pneumatic	Solid Rubber	Pneumatic
				
Part #	210323	210324	210326	210325
Model #	656-21-Q	656-21-Z	656-21-Z2	656-21-PE
Weight	37 lbs	46 lbs	38 lbs	38 lbs
2 wheel capacity	300 lbs	500 lbs	500 lbs	500 lbs
4 wheel capacity	400 lbs	600 lbs	600 lbs	600 lbs
Caster size:	3" x 1.25"	5" x 1.25"	5" x 1.25"	5" x 1.25"

# Wesco® Greenline E-convertible two-in-one truck

### Features:

- Heavy duty tubular steel construction.
- 10" x 2.5" solid rubber wheels, 5" x 1.25" casters.
- Capacity 2 wheel: 700 lbs; 4 wheel: 800 lbs.
- 8" x 12" noseplate.
- Lever activated position conversion.
- Wheel guards.
- Weight 77 lbs.



Part #	210639
Model#	E-CON
Weight	77 lbs
2 Wheel Capacity	700 lbs
4 Wheel Capacity	800 lbs
Wheel	10" x 2.5" Solid Rubber
Caster	5" x 1.25" Hard Rubber



# Wesco® Greenline standard duty steel hand trucks

- Economically priced.
- 500 lb frame capacity.
- Green enamel finish.
- Zinc plated Auto-Loc® axles assure smooth wheel rotation.
- All frames can accommodate an 8" or 10" wheel.

- 7" deep x 14" wide 7 gauge beveled nose plate with radiused corners for safety.
- 1" OD x 14 gauge wall tubular frame.
- Order by part # or model #.

Example:

Part # or Model #  
210461 626-Q

## Series 626

### Features:

- Pin handle with curved back design.
- Welded frame construction.
- 1" O.D. tube.

As shown: 626-Q



## Wheel Choices

Hub: Dimensions: Wheel Type:	Q Poly Offset 8" x 1.75" Semi-Pneumatic	R Aluminium 8" x 1.625" Moldon Rubber	Z8 Poly Offset 8" x 2" Solid Rubber	Z2 Poly Offset 10" x 2.75" Solid Rubber	P Steel Offset 10" x 3.5" Pneumatic	PE Steel Offset 10" x 3.5" Pneumatic
Part #	210461	210466	210330	210361	210456	210356
Model #	626-Q	626-R	626-Z8	626-Z2	626-P	626-PE
Weight	24 lbs	25.5 lbs	25.5 lbs	31 lbs	27.5 lbs	26 lbs
Capacity	300 lbs	500 lbs	500 lbs	500 lbs	500 lbs	500 lbs

## Series 626D

### Features:

- Single loop handle with curved back design.
- Welded frame construction.
- 1" O.D. tube.

As shown: 626D-R



Part #	210462	210467	210331	210362	210457	210357
Model #	626D-Q	626D-R	626D-Z8	626D-Z2	626D-P	626D-PE
Weight	25.5 lbs	27 lbs	27 lbs	32.5 lbs	29 lbs	27.5 lbs
Capacity	300 lbs	500 lbs	500 lbs	500 lbs	500 lbs	500 lbs

## Series 636

### Features:

- Dual handle curved back design.
- Welded frame construction.
- 1" O.D. tube.

As shown: 636-Z8



Part #	210463	210468	210332	210363	210458	210358
Model #	636-Q	636-R	636-Z8	636-Z2	636-P	636-PE
Weight	24.5 lbs	26 lbs	26 lbs	31.5 lbs	28 lbs	26.5 lbs
Capacity	300 lbs	500 lbs	500 lbs	500 lbs	500 lbs	500 lbs

# Wesco® Greenline standard duty steel hand trucks

## Series 646

### Features:

- Dual pin handle with curved back design.
- Welded frame construction.
- 1" O.D. tube.

As shown: 646-Z2



## Series 656

### Features:

- Continuous handle with curved back design.
- Welded frame construction.
- 1" O.D. tube.

As shown: 656-P



## Folding nose extension option



To order field installation simply note part # or model # on P.O.  
To order factory installed option add option part # or model # to the end of the truck part or model #.

Example: 626D-R with 24" nose extension

Part # 210467,054218 or Model # 626D-R-FNG-24F

	Part #	Model #
24" Nose Extension - Field Installation	210249	FNG-24K
24" Nose Extension - Factory Installed	054218	FNG-24F

## Wheel Choices

	Q Poly Offset 8" x 1.75" Semi-Pneumatic	R Aluminium 8" x 1.625" Moldon Rubber	Z8 Poly Offset 8" x 2" Solid Rubber	Z2 Poly Offset 10" x 2.75" Solid Rubber	P Steel Offset 10" x 3.5" Pneumatic	PE Steel Offset 10" x 3.5" Pneumatic
Hub:						
Dimensions:						
Wheel Type:						
Part #	210464	210469	210333	210364	210459	210359
Model #	646-Q	646-R	646-Z8	646-Z2	646-P	646-PE
Weight	25.5 lbs	27 lbs	27 lbs	32.5 lbs	29 lbs	27.5 lbs
Capacity	300 lbs	500 lbs	500 lbs	500 lbs	500 lbs	500 lbs

Part #	210465	210470	210334	210365	210460	210360
Model #	656-Q	656-R	656-Z8	656-Z2	656-P	656-PE
Weight	26 lbs	27.5 lbs	27.5 lbs	33 lbs	29.5 lbs	28 lbs
Capacity	300 lbs	500 lbs	500 lbs	500 lbs	500 lbs	500 lbs

# Wesco® Touch-N-Tilt® ergonomic industrial steel hand trucks

The Touch-N-Tilt® ergonomic feature is an innovative, state of the art device that allows the user to reduce the effort required to break the load over by as much as 66%. This patented product is ideal for employers looking to minimize the physical demands placed on their workforce.



Push a pedal and your load feels lighter – 66% lighter



## Touch-N-Tilt®

### Features:

- Simple and affordable.
- Up to 700 lbs. capacity.
- Available with 8" or 10" wheels.
- Same strong frames used on Wesco 100 series industrial truck.
- U.S. Patent 5,118,124.

As shown: TNT56-Z

## Series TNT26D

- Single loop handle design.
- 48" overall height.



TNT26D HANDLE

## Series TNT36

- Twin handle design with plastic grips.
- 50" overall height.



TNT36 HANDLE

## Series TNT46

- Twin handle high back design with plastic grips.
- 51" overall height.



TNT46 HANDLE

## Series TNT56

- Popular continuous handle design.
- 50" overall height.



TNT56 HANDLE

## Wheel Choices

Hub: Dimensions: Wheel Type:	R Aluminum 8" x 1.625" Moldon Rubber	R1 Steel Offset 8" x 2.5" Semi-Pneumatic	Z Steel Offset 10" x 2.75" Semi-Pneumatic	Z2 Poly Offset 10" x 2.75" Solid Rubber	P Steel Offset 10" x 3.5" Pneumatic	PE Steel Offset 10" x 3.5" Pneumatic
Part #	210516	210517	210518	210521	210519	210520
Model #	TNT26D-R	TNT26D-R1	TNT26D-Z	TNT26D-Z2	TNT26D-P	TNT26D-PE
Capacity	600 lbs	500 lbs	600 lbs	700 lbs	600 lbs	600 lbs
Weight	35.5 lb	41.5 lb	43.5 lbs	43.5 lbs	40.5 lbs	37.5 lbs
Part #	210524	210525	210526	210529	210527	210528
Model #	TNT36-R	TNT36-R1	TNT36-Z	TNT36-Z2	TNT36-P	TNT36-PE
Capacity	600 lbs	500 lbs	600 lbs	700 lbs	600 lbs	600 lbs
Weight	35.5 lb	41.5 lb	43.5 lbs	43.5 lbs	40.5 lbs	37.5 lbs
Part #	210532	210533	210534	210537	210535	210536
Model #	TNT46-R	TNT46-R1	TNT46-Z	TNT46-Z2	TNT46-P	TNT46-PE
Capacity	600 lbs	500 lbs	600 lbs	700 lbs	600 lbs	600 lbs
Weight	36.5 lb	42.5 lb	44.5 lbs	41.5 lbs	41.5 lbs	39.5 lbs
Part #	210544	210545	210546	210549	210547	210548
Model #	TNT56-R	TNT56-R1	TNT56-Z	TNT56-Z2	TNT56-P	TNT56-PE
Capacity	600 lbs	500 lbs	600 lbs	700 lbs	600 lbs	600 lbs
Weight	33.5 lb	39.5 lb	41.5 lbs	41.5 lbs	38.5 lbs	35.5 lbs

# Wesco® Freight King® hand trucks

## Freight King® Features:

- Replaceable hardwood handles are essential for use in cold environments.
- Frame made from one piece heavy gauge pressed steel.
- Frame is reinforced at critical points.
- Bolted construction for easy parts replacement.
- Beveled open 5" or 8" nose is made of .5" thick steel.
- Legs on T-2 frames prevent handle damage and allow horizontal loading.
- Red enamel finish.
- Order by Part # or Model #.

## Standard Freight King

### Features:

- Curved handles.
- 6" x 1.5" cast iron center moldon rubber wheels with .75" ball bearings.
- 450 lb capacity.

As shown: T-1-8

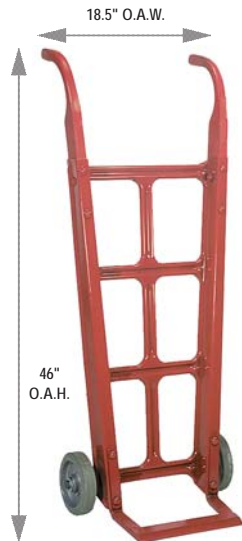

Part #	Model #	Nose Length	Legs	Weight
210090	T-1	5"	No	30 lbs
210092	T-1-8	8"	No	31 lbs
210091	T-L	5"	Yes	30 lbs
210093	T-L-8	8"	Yes	34 lbs

→  
Legs



## Docker Freight King

### Features:

- Legs and wheel guards on all models.
- 8" x 2" aluminum center moldon rubber wheels with 3/4" ball bearings.
- 650 lb capacity.

As shown: T-2



Part #	Model #	Handle	Height	Width	Nose Length	Weight
210094	T-2	Straight	52"	20"	5"	36 lbs
210095	T-2-8	Straight	52"	20"	8"	37 lbs
210096	T-2C	Curved	48"	19"	5"	36 lbs
210097	T-2C-8	Curved	48"	19"	8"	37 lbs



## Freight King Folding Nose Option

- 21" long x 12.75".



To order option, add part # or model # to truck.  
FOR EXAMPLE:

Part # \_\_\_\_\_ or Model # + Option #  
210090, 054200 T-1 -FN21F

Part #	Kit Model #	Factory Installed	
		Part #	Model #
210100	FN-21K	054200	FN-21F





# Wesco® specialty hand trucks

## Standard 186 Series

### Features:

- Rear axle designs allow loading and unloading of pallets. Rear caster design allows small diameter turns in tight areas.
- Combination two handle and utility bar handle design.
- Distribution of load over 4 wheels improves load control.
- All wheels have ball bearings.

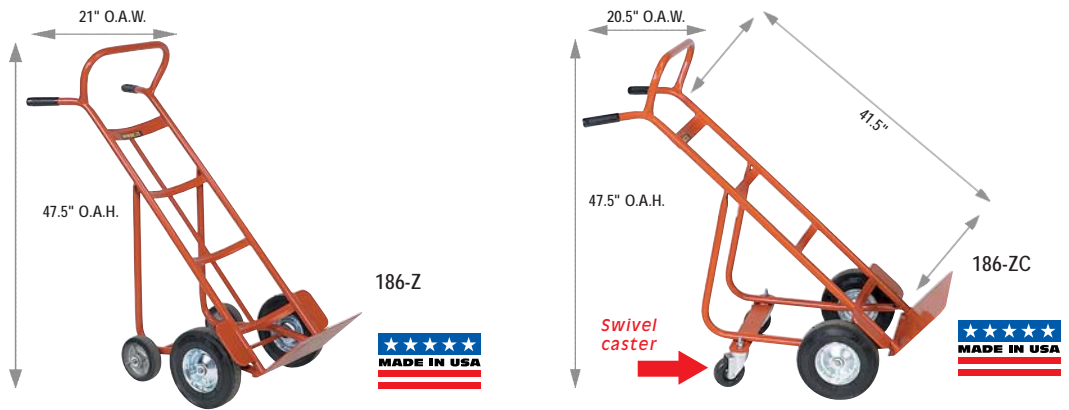

Part #	Model #	Height	Width	Nose Plate Depth	Capacity	Weight	Front Wheels	Rear Wheels
210050	186-Z	47.5"	21"	8"	800 lbs	53 lbs	10" x 2.75" Semi-Pneumatic	6" Moldon Rubber/Axle
210051	186-RK8	51"	22"	13"	900 lbs	59 lbs	8" x 2.5" Balloon Cushion	6" Moldon Rubber/Axle
210125	186ZC	47.5"	20.5"	8"	800 lbs	53 lbs	10" x 2.75" Semi-Pneumatic	4 x 1.25" Poly/Swivel Casters

## Steel Collaps-A-Trucks

### Features:

- All welded construction.
- Collapses for convenient storage and portability.
- Ideal for salesmen, delivery men, or repairmen.
- Ships boxed via UPS.
- Polyolefin wheels.

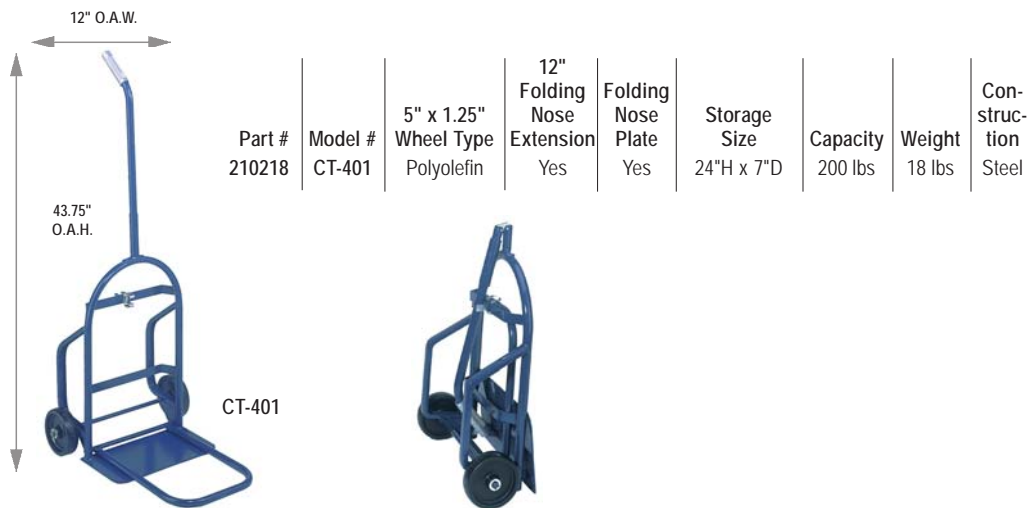

## SideRoller

### Features:

- Standard hand truck or side rolling cart capability.
- Side rolling position allows wide product loads to fit through narrow doorways.
- Wheels maintain full contact with the floor in both transport positions.
- Spring loaded locking mechanism provides greater steering control and stability.



Part #	210270
Model #	SR1-Z
Height	48.211"
Width	20.4" standard 22.25" lateral position
Nose Plate Depth	7"
Capacity	500 lbs
Weight	38.5 lbs
Wheels	10" x 2.75" Semi-Pneumatic

# Wesco® heavy duty hand trucks

## Heavy Duty Shovel Nose Trucks

### Features:

- Five year weld guarantee.
- 13" deep x 17.5" x .25" thick tapered nose plate.
- 1" heavy duty Sch-40 pipe frame.
- Easy grip continuous handle frame design.
- 3/4" axle.
- 8" x 2" cast iron moldon rubber or 12" pneumatic wheels.
- Wheel guards.

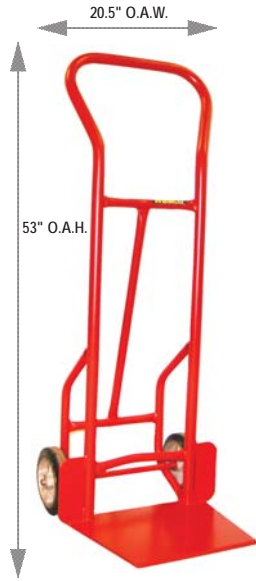

ST2-HB



Heavy Duty Shovel Nose Truck



ST2-P12

Part #	210064	210066
Model #	ST-2HB	ST2-P12
Capacity	900 lbs	800 lbs
Weight	59.5 lbs	61 lbs
Wheel	8"x2" M.O.	12" Pneumatic

*12" Pneumatic Wheel, great for construction sites*

## Heavy Duty Hand Truck

### Features:

- 8" x 2" cast iron center moldon rubber wheels.
- Steel reinforced nose plate.
- .75 inch axle.
- Five handle choices.



146-HB



### Handle Choices



Part #	210263	210264	210134	210135	210265
Model #	126RN-HB	126DRN-HB	136RN-HB	146RN-HB	156RN-HB
Capacity	800 lbs	800 lbs	800 lbs	800 lbs	800 lbs
Weight	39 lbs	40 lbs	40 lbs	40 lbs	38 lbs

# Wesco® heavy duty hand trucks

## Heavy Duty Warehouse Trucks

### Features:

- Five year weld guarantee.
- Large 10" deep x 16.5" wide x .25" thick tapered nose plate.
- 1" heavy duty Sch-40 pipe frame.
- Wheel guards standard.
- Dual handle design.
- Kick out four wheel model – TM4W or standard two wheel model.
- 3.5" moldon rubber swivel casters on four wheel kick out trucks.





TM4W-HB



TM-HB

## Wheel Choices

	H B Cast Iron 8" x 2" Moldon Rubber	P B Steel Offset 10" x 3.5" Pneumatic	BT 1 Cast Iron 10" x 2.5" Moldon Rubber
Hub:	Cast Iron	Steel Offset	Cast Iron
Dimensions:	8" x 2"	10" x 3.5"	10" x 2.5"
Wheel Type:	Moldon Rubber	Pneumatic	Moldon Rubber
			
Part #	210055	210056	210239
Model #	TM-HB	TM-PB	TM-BT
Capacity	900 lbs	700 lbs	1,000 lbs
Weight	54 lbs	49 lbs	67 lbs
Part #	210060	210061	210062
Model #	TM4W-HB	TM4W-PB	TM4W-BT
Capacity	900 lbs	700 lbs	1,000 lbs
Weight	66 lbs	61 lbs	79 lbs
Caster	3.5"	3.5"	3.5"

## 156DH Drum/Hand Truck



### Features:

- Utility of a hand truck & drum truck.
- Chime hook works with 55 and 30 gallon drums.
- Curved frame holds 5 gallon pails and kegs.
- With noseplate resting flat on floor, 18" to center of lowered chime hook.



156DH-Z

## Wheel Choices

	Z Steel Offset 10" x 2.75" Semi-Pneumatic	H Cast Iron 8" x 2" Moldon Rubber
Hub:	Steel Offset	Cast Iron
Dimensions:	10" x 2.75"	8" x 2"
Wheel Type:	Semi-Pneumatic	Moldon Rubber
		
Part #	210340	210349
Model #	156DH-Z	156DH-HB
Capacity	700 lbs	800 lbs
Weight	39 lbs	42.5 lbs
Axle	.625"	.75"
Bearing	Ball Bearing	Roller Bearing

# Wesco® super economy hand truck & high frame package truck

## Economy Hand Truck

### Features:

- 7.5" x 14" nose plate.
- 16 gauge frame.
- Full pneumatic ball bearing wheels.
- SR models have 10" solid rubber wheels.
- Ships KD.

## Jr Economy Hand Truck

### Features:

- Same as Economy except shorter.
- SR models have 10" solid rubber wheels.



	Economy	Jr Economy	Economy SR	Jr Economy SR
Wheel	10" Pneumatic	10" Pneumatic	10" Solid Rubber	10" Solid Rubber
Part #	210127	210213	210215	210216
Capacity	500 lbs	500 lbs	500 lbs	500 lbs
O.A. Width	21.5"	21.5"	21.5"	21.5"
O.A. Height	51"	45.5"	51"	45.5"
Weight	26 lbs	25 lbs	40 lbs	39 lbs

## Economy Wide Plate Hand Truck

### Features:

- Pneumatic wheels.
- Wheel guards and vinyl strips protect cargo.
- 20" wide nose plate.
- SR models have 10" solid rubber wheels.

	Wide Plate Economy	Wide Plate Economy SR
Wheel	10" Pneumatic	10" Solid Rubber
Part #	210214	210217
Capacity	600 lbs	500 lbs
Weight	29 lbs	43 lbs



## High Frame Package Truck

### Features:

- 8" x 2" solid rubber ball bearing wheels.
- Reinforced frame.
- Folding nose option.



166RN-Z8-FNR-24F  
Shown with optional folding nose.

High Frame	
Part #	210261
Model #	166RN-Z8
Capacity	800 lbs
Weight	36 lbs

	Part #	Model #	Capacity	Weight
Folding nose option field installed	210262	FNR-24K	800 lbs	8 lbs
Folding nose option factory installed	054224	FNR-24F	800 lbs	8 lbs



# Mighty-Lite® magnesium frame hand trucks

## Mighty-Lite® Features:

- Super strong nose with 5 year guarantee against breakage.
  - Heavy duty magnesium frame – the strongest light weight truck available.
  - Magnesium is 33% lighter than aluminum and is the world's lightest structural metal.
  - Available knocked down and boxed or fully set up, bolted construction for easy parts interchange.
  - Available options include: stairglides, brake, 12" deep noses, folding nose extensions, top extensions, center straps, Touch-N-Tilt® OPTION and hanger hooks (see page 38).
  - Wheel guards are standard with S14 noseplates.
- Order by part # or model #.

Example: Part # or Model #

Part #      Series + Nose + Wheel  
220004      500 - S14 - Z

## Wheel Choices

**Series 500**

**Features:**

- Super light design.
- Economical cost.
- Continuous handle.
- Straight back frame.

S14 Nose:  
14" w. x 7.625" d.  
S18 Nose:  
18" w. x 7.625" d.

As shown:  
500-S14-R1



**Series 510**









**Features:**

- Reinforced upper and lower frame for added strength.
- Continuous handle.
- Straight back frame.
- Comfortable vinyl covered handle at no extra cost.

S14 Nose:  
14" w. x 7.625" d.  
S18 Nose:  
18" w. x 7.625" d.

As shown:  
510-S14-R3



Hub: Dimensions: Wheel Type:	R1 Steel Offset 8" x 2.5" Semi-Pneumatic	R3 Aluminum Offset 8" x 1.625" Moldon Rubber	Z Steel Offset 10" x 2.75" Semi-Pneumatic	Z2 Poly Offset 10" x 2.75" Solid Rubber	P Steel Offset 10" x 3.5" Pneumatic	PE Steel Offset 10" x 3.5" Pneumatic
						
<b>S14" Nose</b>						
Part #	220003	220002	220004	220246	220005	220261
Model #	500-S14-R1	500-S14-R3	500-S14-Z	500-S14-Z2	500-S14-P	500-S14-PE
Capacity	400 lbs	400 lbs	400 lbs	400 lbs	400 lbs	400 lbs
Weight	23 lbs	20 lbs	28 lbs	26.5 lbs	23 lbs	21.5 lbs
<b>S18" Nose</b>						
Part #	220008	220007	220009	220247	220010	220262
Model #	500-S18-R1	500-S18-R3	500-S18-Z	500-S18-Z2	500-S18-P	500-S18-PE
Capacity	400 lbs	400 lbs	400 lbs	400 lbs	400 lbs	400 lbs
Weight	25 lbs	22 lbs	30 lbs	28.5 lbs	25 lbs	23.5 lbs
						
<b>S14" Nose</b>						
Part #	220013	220012	220014	220248	220015	220263
Model #	510-S14-R1	510-S14-R3	510-S14-Z	510-S14-Z2	510-S14-P	510-S14-PE
Capacity	450 lbs	600 lbs	500 lbs	500 lbs	600 lbs	600 lbs
Weight	24 lbs	21 lbs	29 lbs	27.5 lbs	24 lbs	22.5 lbs
<b>S18" Nose</b>						
Part #	220018	220017	220019	220249	220020	220264
Model #	510-S18-R1	510-S18-R3	510-S18-Z	510-S18-Z2	510-S18-P	510-S18-PE
Capacity	450 lbs	600 lbs	500 lbs	500 lbs	600 lbs	600 lbs
Weight	26 lbs	23 lbs	31 lbs	29.5 lbs	26 lbs	24.5 lbs
						

# Mighty-Lite® magnesium frame hand trucks

## Wheel Choices

### Series 520

#### Features:

- Straight, high back frame for tall loads.
- Heavy duty pin handle for one handed control.
- Reinforced lower frame.
- Comfortable vinyl hand grip.

S14 Nose:  
14" w. x 7.625" d.  
S18 Nose:  
18" w. x 7.625" d.

As shown:  
520-S14-Z



Hub: Dimensions: Wheel Type:	R1 Steel Offset 8" x 2.5" Semi-Pneumatic	R3 Aluminum Offset 8" x 1.625" Moldon Rubber	Z Steel Offset 10" x 2.75" Semi-Pneumatic	Z2 Poly Offset 10" x 2.75" Solid Rubber	P Steel Offset 10" x 3.5" Pneumatic	PE Steel Offset 10" x 3.5" Pneumatic
<b>S14" Nose</b>						
Part #	220023	220022	220024	220250	220025	220265
Model #	520-S14-R1	520-S14-R3	520-S14-Z	520-S14-Z2	520-S14-P	520-S14-PE
Capacity	450 lbs	600 lbs	500 lbs	500 lbs	600 lbs	600 lbs
Weight	24 lbs	21 lbs	29 lbs	27.5 lbs	24 lbs	22.5 lbs
<b>S18" Nose</b>						
Part #	220028	220027	220029	220251	220030	220266
Model #	520-S18-R1	520-S18-R3	520-S18-Z	520-S18-Z2	520-S18-P	520-S18-PE
Capacity	450 lbs	600 lbs	500 lbs	500 lbs	600 lbs	600 lbs
Weight	26 lbs	23 lbs	31 lbs	29.5 lbs	26 lbs	24.5 lbs



### Series 525\*

#### Features:

- Open back nose plate and curved frame.
- Excellent for kegs and other cylindrical objects.
- High back frame for tall loads.
- Heavy duty pin handle.
- Reinforced lower frame.
- Comfortable vinyl hand grip.

C14 Nose:  
14" w. x 7.625" d.

As shown:  
525-C14-Z2



<b>C14" Nose</b>						
Part #	220033	220032	220034	220252	220035	220267
Model #	525-C14-R1	525-C14-R3	525-C14-Z	525-C14-Z2	525-C14-P	525-C14-PE
Capacity	450 lbs	600 lbs	500 lbs	600 lbs	600 lbs	600 lbs
Weight	23.5 lbs	20.5 lbs	28.5 lbs	27 lbs	23.5 lbs	22 lbs

\*Open back nose plate only available as C14" nose.



### Series 530\*

#### Features:

- Open back nose plate and curved frame.
- Excellent for kegs and other cylindrical objects.
- Super light design.
- Economical cost.
- Continuous handle.

C14 Nose:  
14" w. x 7.625" d.

As shown:  
530-C14-P



<b>C14" Nose</b>						
Part #	220038	220037	220039	220253	220040	220268
Model #	530-C14-R1	530-C14-R3	530-C14-Z	530-C14-Z2	530-C14-P	530-C14-PE
Capacity	400 lbs	400 lbs	400 lbs	400 lbs	400 lbs	400 lbs
Weight	23 lbs	20 lbs	28 lbs	26.5 lbs	23 lbs	21.5 lbs

\*Open back nose plate only available as C14" nose.



# Mighty-Lite® magnesium frame hand trucks

## Series 540\*

### Features:

- Open back nose plate and curved frame.
- Excellent for kegs and other cylindrical objects.
- Reinforced upper frame for added strength.
- Continuous handle.
- Comfortable vinyl covered handle at no extra cost.

14" wide by 7.625" deep nose  
As shown: 540-C14-P



## Wheel Choices

Hub: Dimensions: Wheel Type:	R1 Steel Offset 8" x 2.5" Semi-Pneumatic	R3 Aluminum Offset 8" x 1.625" Moldon Rubber	Z Steel Offset 10" x 2.75" Semi-Pneumatic	Z2 Poly Offset 10" x 2.75" Solid Rubber	P Steel Offset 10" x 3.5" Pneumatic	PE Steel Offset 10" x 3.5" Pneumatic
<b>C14" Nose</b>						
Part #	220043	220042	220044	220254	220045	220269
Model #	540-C14-R1	540-C14-R3	540-C14-Z	540-C14-Z2	540-C14-P	540-C14-PE
Capacity	450 lbs	600 lbs	500 lbs	500 lbs	600 lbs	600 lbs
Weight	23.5 lbs	20.5 lbs	28.5 lbs	27 lbs	23.5 lbs	22 lbs

\*Open back nose plate only available as C14" nose.

## Series 550

### Features:

- Reinforced upper and lower frame for added strength.
- Straight back frame.
- Twin handles for two handed load control.
- Comfortable vinyl hand grips.

S14 - 14" wide by 7.625" deep nose  
S18 - 18" wide by 7.625" deep nose  
As shown: 550-S14-R1

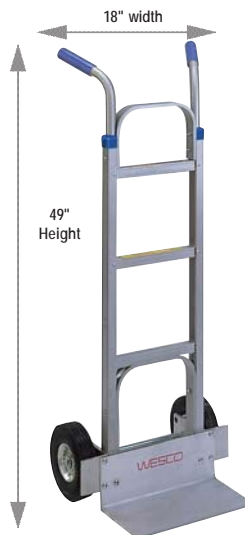

<b>S14" Nose</b>						
Part #	220048	220047	220049	220255	220050	220270
Model #	550-S14-R1	550-S14-R3	550-S14-Z	550-S14-Z2	550-S14-P	550-S14-PE
Capacity	450 lbs	600 lbs	500 lbs	500 lbs	600 lbs	600 lbs
Weight	24 lbs	21 lbs	29 lbs	27.5 lbs	24 lbs	22.5 lbs
<b>S18" Nose</b>						
Part #	220053	220052	220054	220256	220055	220271
Model #	550-S18-R1	550-S18-R3	550-S18-Z	550-S18-Z2	550-S18-P	550-S18-PE
Capacity	450 lbs	600 lbs	500 lbs	500 lbs	600 lbs	600 lbs
Weight	26 lbs	23 lbs	31 lbs	29.5 lbs	26 lbs	24.5 lbs

## Series 560\*

### Features:

- Open back nose plate and curved frame.
- Excellent for kegs and other cylindrical objects.
- Twin handles for two handed load control.
- Reinforced upper frame for added strength.
- Comfortable vinyl hand grips.

14" wide by 7.625" deep nose  
As shown: 560-C14-R3



<b>C14" Nose</b>						
Part #	220058	220057	220059	220257	220060	220272
Model #	560-C14-R1	560-C14-R3	560-C14-Z	560-C14-Z2	560-C14-P	560-C14-PE
Capacity	450 lbs	600 lbs	500 lbs	500 lbs	600 lbs	600 lbs
Weight	23.5 lbs	20.5 lbs	28.5 lbs	27 lbs	23.5 lbs	22 lbs

\*Open back nose plate only available as C14" nose.

# Mighty-Lite® magnesium frame hand trucks

## Series 570

### Features:

- High back frame for tall loads.
- Straight back frame.
- Heavy duty safety loop handle design for one handed control.
- Reinforced upper and lower frame for added strength.

S14 - 14" wide by 7.625" deep nose  
S18 - 18" wide by 7.625" deep nose



## Series 575\*

### Features:

- Open back nose plate and curved frame.
- Excellent for kegs and other cylindrical objects.
- High back frame for tall loads.
- Heavy duty safety loop handle design for one handed control.
- Reinforced upper and lower frame for added strength.
- 14" wide by 7.625" deep nose



## Touch-N-Tilt® option for Mighty-Lite® trucks

### Features

- Simple and affordable.
- Up to 600 lbs. capacity.
- Available with 8" or 10" wheels.
- U.S. Patent 5,118,124.
- Available with stair glides.

The Touch-N-Tilt® ergonomic feature is an innovative, state of the art device that allows the user to reduce the effort required to break the load over by as much as 66%. This patented product is ideal for employers looking to minimize the physical demands placed on their workforce.

Touch-N-Tilt® Feature (Must be factory installed)

For 8" wheel trucks		For 10" wheel trucks	
Part #	Model #	Part #	Model #
054220	TNT8	054221	TNT10

To order TNT option, add part # or model # to truck.

For example:

Part # or Model #  
Part# + Option# + TNT# - Series + Nose + Wheel + Option + TNT#  
220012 , 054212, 054220 - 510 - S14 - R3 T2F TNT8

## Wheel Choices

Hub: Dimensions: Wheel Type:	R1 Steel Offset 8" x 2.5" Semi-Pneumatic	R3 Aluminum Offset 8" x 1.625" Moldon Rubber	Z Steel Offset 10" x 2.75" Semi-Pneumatic	Z2 Poly Offset 10" x 2.75" Solid Rubber	P Steel Offset 10" x 3.5" Pneumatic	PE Steel Offset 10" x 3.5" Pneumatic
<b>S14" Nose</b>						
Part #	220063	220062	220064	220258	220065	220273
Model #	570-S14-R1	570-S14-R3	570-S14-Z	570-S14-Z2	570-S14-P	570-S14-PE
Capacity	450 lbs	600 lbs	500 lbs	500 lbs	600 lbs	600 lbs
Weight	24.5 lbs	21.5 lbs	29.5 lbs	28 lbs	24.5 lbs	23 lbs
<b>S18" Nose</b>						
Part #	220068	220067	220069	220259	220070	220274
Model #	570-S18-R1	570-S18-R3	570-S18-Z	570-S18-Z2	570-S18-P	570-S18-PE
Capacity	450 lbs	600 lbs	500 lbs	500 lbs	600 lbs	600 lbs
Weight	26.5 lbs	23.5 lbs	31.5 lbs	30 lbs	26.5 lbs	25 lbs
<b>C14" Nose</b>						
Part #	220073	220072	220074	220260	220075	220275
Model #	575-C14-R1	575-C14-R3	575-C14-Z	575-C14-Z2	575-C14-P	575-C14-PE
Capacity	450 lbs	600 lbs	500 lbs	500 lbs	600 lbs	600 lbs
Weight	24 lbs	21 lbs	29 lbs	27.5 lbs	24 lbs	22.5 lbs

\*Open back nose plate only available as C14" nose.

Push a pedal and your load feels lighter - 66% lighter

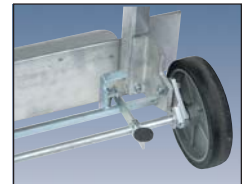



To order option, add part # or model # to truck. For example:

Part #                      or Model #  
 Part # + Option #      Series + Nose + Wheel + Option  
 220004 , 054211        500 - S14 - Z - S2F

## Stair glides



Deluxe cast aluminum stair glides factory installed:	Part #	Model #
Stair glides without wearstrips	054211	S2F
Stair glides with wearstrips	054213	S3F
Touch-N-Tilt stair glides without wearstrips	054212	T2F
Touch-N-Tilt stair glides with wearstrips	054222	T3F

Deluxe cast aluminum stair glides field installed:	Part #	Model #
Stair glide set without wearstrips	220349	S2K
Stair glides with wearstrips	220351	S3K
Touch-N-Tilt stair glide set without wearstrips	220350	T2K
Touch-N-Tilt stair glides with wearstrips	220338	T3K

## Top extensions



	Factory Installed		Kit for Field Installation	
	Part #	Model #	Part #	Model #
50" top extension	054232	50UF	220098	50UK
52" top extension	054206	52UF	220080	52UK
60" top extension	054207	60UF	220081	60UK
68" top extension	054209	68UF	220094	68UK

## Center straps



	Factory Installed		Kit for Field Installation	
	Part #	Model #	Part #	Model #
Single Strap	054205	CSF	220085	CSK
Double Strap	054228	2CSF	220088	2CSK

## Folding Nose



	Factory Installed		Kit for Field Installation	
	Part #	Model #	Part #	Model #
20" Folding Nose	054202	F2EF	220082	F2E
30" Folding Nose	054203	F3EF	220083	F3E

## Hanger Hooks



	Factory Installed		Kit for Field Installation	
	Part #	Model #	Part #	Model #
Hanger Hook	054204	HHF	220084	HHK

## Brake Option



Factory installed brake option for:

	Part #	Model #
Continuous handle	054214	BCF
Pin handle	054215	BPF
Twin handle	054216	BTF
"D" handle	054217	BDF



Field installed brake kit option for:

	Part #	Model #
Continuous handle	220354	BCK
Pin handle	220355	BPK
Twin handle	220356	BTK
"D" handle	220357	BDK

## 12" Deep Nose Plate



Factory installed 12" deep x 16" wide nose plate for series 500, 510, 520, 550, and 570:

Part #	Model #
054010	S26F

Field installed 12" deep x 16" wide nose plate kit for series 500, 510, 520, 550, and 570:

Part #	Model #
220314	S26K

## Custom Nose Plates



Coca-Cola®, Pepsi-Cola®, Budweiser®, and Coors® stamped nose plates are available on all straight back Wesco Mighty-Lite hand trucks at no extra charge. Curved back frame models have stamped cross-braces instead of nose plates.

Wesco can also custom emboss Mighty-Lites with your distributorship's or customer's name. Please call to obtain details on this inexpensive and long lasting form of advertising.

# Wesco® Cobra-Lite aluminum hand trucks



## Cobra-Lite features:

- All aluminum construction.
- Heavy duty cast 7.5" by 14" or 7.5" by 18" wide nose plate options.
- Quality light weight truck at an economical price .
- Ships KD and boxed or as components (see page 46 and 47).
- Capacity: 600 lbs.
- Assembly option available.
- All 2" wide cross braces for additional strength. Great for advertising label.

### Series 410

#### Features:

- Continuous handle.
- 49" overall height.
- Most popular model.
- Available with vinyl dipped handle. See component system on page 44.

As shown:  
410-T14-R3



### Series 420

#### Features:

- High back pin handle.
- Comfortable vinyl hand grip.
- 52" overall height.

As shown:  
420-T18-P



## Wheel Choices

Hub: Dimensions: Wheel Type:	R2 Poly 8" x 1.625" Moldon Rubber	R3 Aluminum Offset 8" x 1.625" Moldon Rubber	Z Steel Offset 10" x 2.75" Semi-Pneumatic	Z2 Poly Offset 10" x 2.75" Solid Rubber	P Steel Offset 10" x 3.5" Pneumatic	PE Steel Offset 10" x 3.5" Pneumatic
<b>T14" Nose</b>						
Part #	220320	220332	220321	220370	220322	220375
Model #	410-T14-R2	410-T14-R3	410-T14-Z	410-T14-Z2	410-T14-P	410-T14-PE
Capacity	600 lbs	600 lbs	600 lbs	600 lbs	600 lbs	600 lbs
Weight	16.5 lbs	19.5 lbs	27.5 lbs	26 lbs	22.5 lbs	21 lbs
<b>T18" Nose</b>						
Part #	220380	220392	220381	220396	220382	220365
Model #	410-T18-R2	410-T18-R3	410-T18-Z	410-T18-Z2	410-T18-P	410-T18-PE
Capacity	600 lbs	600 lbs	600 lbs	600 lbs	600 lbs	600 lbs
Weight	17.5 lbs	20.5 lbs	28.5 lbs	27 lbs	23.5 lbs	22 lbs
<b>T14" Nose</b>						
Part #	220323	220333	220324	220371	220325	220376
Model #	420-T14-R2	420-T14-R3	420-T14-Z	420-T14-Z2	420-T14-P	420-T14-PE
Capacity	600 lbs	600 lbs	600 lbs	600 lbs	600 lbs	600 lbs
Weight	16.5 lbs	19.5 lbs	27.5 lbs	26 lbs	22.5 lbs	21 lbs
<b>T18" Nose</b>						
Part #	220383	220393	220384	220397	220385	220366
Model #	420-T18-R2	420-T18-R3	420-T18-Z	420-T18-Z2	420-T18-P	420-T18-PE
Capacity	600 lbs	600 lbs	600 lbs	600 lbs	600 lbs	600 lbs
Weight	17.5 lbs	20.5 lbs	28.5 lbs	27 lbs	23.5 lbs	22 lbs

# Wesco® Cobra-Lite aluminum hand trucks



## Series 450

### Features:

- Twin handle style with vinyl grips.
- 49" overall height.

As shown:  
450-T14-R3



## Wheel Choices

Hub: Dimensions: Wheel Type:	R2 Poly 8" x 1.625" Moldon Rubber	R3 Aluminum Offset 8" x 1.625" Moldon Rubber	Z Steel Offset 10" x 2.75" Semi-Pneumatic	Z2 Poly Offset 10" x 2.75" Solid Rubber	P Steel Offset 10" x 3.5" Pneumatic	PE Steel Offset 10" x 3.5" Pneumatic
T14" Nose						
Part #	220326	220334	220327	220372	220328	220377
Model #	450-T14-R2	450-T14-R3	450-T14-Z	450-T14-Z2	450-T14-P	450-T14-PE
Capacity	600 lbs	600 lbs	600 lbs	600 lbs	600 lbs	600 lbs
Weight	17 lbs	20 lbs	28 lbs	26.5 lbs	23 lbs	21.5 lbs

T18" Nose						
Part #	220386	220394	220387	220398	220388	220367
Model #	450-T18-R2	450-T18-R3	450-T18-Z	450-T18-Z2	450-T18-P	450-T18-PE
Capacity	600 lbs	600 lbs	600 lbs	600 lbs	600 lbs	600 lbs
Weight	18 lbs	21 lbs	29 lbs	27.5 lbs	24 lbs	22.5 lbs

## Series 470

### Features:

- High back loop handle.
- 52" overall height.

As shown:  
470-T14-P2



T14" Nose						
Part #	220329	220335	220330	220373	220331	220378
Model #	470-T14-R2	470-T14-R3	470-T14-Z	470-T14-Z2	470-T14-P	470-T14-PE
Capacity	600 lbs	600 lbs	600 lbs	600 lbs	600 lbs	600 lbs
Weight	17 lbs	20 lbs	28 lbs	26.5 lbs	23 lbs	21.5 lbs

T18" Nose						
Part #	220389	220395	220390	220399	220391	220368
Model #	470-T18-R2	470-T18-R3	470-T18-Z	470-T18-Z2	470-T18-P	470-T18-PE
Capacity	600 lbs	600 lbs	600 lbs	600 lbs	600 lbs	600 lbs
Weight	18 lbs	21 lbs	29 lbs	27.5 lbs	24 lbs	22.5 lbs

# Wesco® Cobra-Lite aluminum bakery truck & options



## High Glide Bakery Truck

### Features:

- 15" extended noseplate for large loads.
- Coated continuous handle and frame extension.
- Touch-N-Tilt feature for easier load break over (See page 40).
- Extended stairglide, full 16" slide surface.



Part #	220472
Model #	HGBT
Height	52.5"
Width	19"
Nose Plate	14" w. x 15" l. beveled
Capacity	300 lbs
Weight	38 lbs
Wheels	10" Balloon Cushion

## Cobra-Lite Folding Nose, Top Extension and Brake Options



### Folding nose for T-14 & T-18 nose plates

	Field Install Kit		Factory Installed	
	Part #	Model #	Part #	Model #
20" Long	220346	F2	054223	F2F
30" Long	220343	F3	054225	F3F



### Top extensions for 410 & 450 models

	Field Install Kit		Factory Installed	
	Part #	Model #	Part #	Model #
44" High	220347	44UK	050144	44UF
52" High	220080	52UK	054206	52UF
60" High	220081	60UK	054207	60UF
68" High	220094	68UK	054209	68UF
52" High	220079	52URK (Red Plastic Coated)	050186	52URF
60" High	220071	60URK (Red Plastic Coated)	050181	60URF



### Boxed brake option for field installation

	Part #	Model #		Part #	Model #
Continuous	220354	BCK	Twin handle	220356	BTK
Pin handle	220355	BPK	"D" handle	220357	BDK

## Cobra-Lite Stairglide and Stairclimber Options



	Field Install Kit		Factory Installed	
	Part #	Model #	Part #	Model #
Stairglide pair without wearstrips	220349	S2K	054211	S2F
Stairglide pair with wearstrips	220351	S3K	054213	S3F



	Field Install Kit		Factory Installed	
	Part #	Model #	Part #	Model #
Steel stairglide pair with wearstrips	220340	S4K	054236	S4F
Cast aluminum stairclimber pair with continuous rolling belt (8" wheel only)	220339	S5K	054237	S5F





*dedicated to finding a cure*

## What You Should Know About Juvenile Diabetes

At age 2½ our grandson, Jonah, developed juvenile or type 1 diabetes. As a result, I have tried to learn as much as I can about the disease and what is being done to find a cure. It will be cured.

As a Board member of the Philadelphia Chapter of the Juvenile Diabetes Research Foundation (JDRF), I am trying to spread awareness about the disease. I thought the following information might be of interest to you, our Wesco friends and customers.

### Facts about Diabetes and JDRF

JDRF was founded in 1970 by the parents of children with juvenile diabetes—a disease that strikes children suddenly, makes them insulin dependent for life, and carries the constant threat of devastating complications. Since inception, JDRF has provided more than \$800 million to diabetes research worldwide. In a typical year, 85% of JDRF’s expenditures directly support research and education about research. JDRF’s mission is constant: to find a cure for diabetes and its complications through the support of research. 100% of all “Major Gifts” go directly to research.

The Juvenile Diabetes Research Foundation International (JDRF) is the leading charitable funder and advocate of type 1 (juvenile) diabetes research worldwide. The mission of JDRF is to find a cure for diabetes and its complications through the support of research.

### General Diabetes Facts

Diabetes is a chronic, debilitating disease affecting every organ system. There are two major types of diabetes: type 1 diabetes (an autoimmune disease also known as juvenile diabetes) and type 2 diabetes (a metabolic disorder also known as adult onset diabetes).

### Type 1 (Juvenile) Diabetes Facts

Type 1 (juvenile) diabetes strikes children suddenly, makes them dependent on injected or pumped insulin for life, and carries the constant threat of devastating complications. While diagnosis most often occurs in childhood and adolescence, it can and does strike adults as well.

### Areas of Scientific Investigation

- Clinical Trials
- Islet Transplantation
- Tolerance
- Stem Cells
- Beta Cell Development
- Beta Cell Regeneration
- Retinopathy
- Neuropathy
- Nephropathy
- Hydroglycemia
- Beta Cell Function
- Wound Healing
- Immunology
- Genetics
- Environmental Triggers
- Gene Therapy

### The Scope of Diabetes

Over 18 million Americans have diabetes (6.3 percent of population).

Diagnosed: 13 Million; Undiagnosed: 5.2 Million.

Over 1.3 million Americans have type 1 diabetes. 194 Million people have diabetes worldwide.

According to World Health Organization estimates, this number will more than double by 2030.

In the U.S., a new case of diabetes is diagnosed every 30 seconds; over 1.3 million people are diagnosed each year.

For more information, contact your local JDRF Chapter. [www.jdf.org](http://www.jdf.org)

Thank you.

Allen Apter

President, Wesco Industrial Products, Inc.

# Design it with Wesco® Cobra-lite components

## Handles



**40R-Red 055143**  
**40B-Blue 050222**  
Continuous handle  
with vinyl grip

**45**  
Twin handle  
w/brace 220119

**41**  
Continuous handle  
151512

**42**  
Pin handle 151511

**47**  
Loop handle 151510  
Can not be used with curved  
frame (5).

**46**  
Super D handle  
052512

**48**  
Deep D handle  
052510

## Frames



**0**  
Straight Frame  
153855

**5**  
Curved Frame  
153897

## Magnesium Nose



**M14 (cast)**  
14" W x 7.5" D  
151523



## Aluminum Noses



**T14 (cast)**  
14" W x 7.5" D  
151521

**T18 (cast)**  
18" W x 7.5" D  
151533

**E14 (extruded)**  
14" W x 7.625" D  
220287

**E16 (extruded)**  
16" W x 12" D  
220286

**E18 (extruded)**  
18" W x 7.625" D  
220285

**EC16 (extruded)**  
Recessed Heel  
16" W x 12" D  
220506  
For Curved  
Frame Only

## Wheels



**P**  
Steel Offset Hub  
10" x 3.5"  
Pneumatic Tire  
054045

**PE**  
Steel Offset Hub  
10" x 3.5"  
Pneumatic Tire  
054231

**PWT**  
Steel Offset Hub  
10" x 3.5"  
Pneumatic  
Wide Tread Tire  
220319

**CF**  
Steel Offset Hub  
10" x 3"  
Carefree 220348 -  
Microcellular  
Polyurethane. Will not  
go flat

**BC10**  
Poly Hub  
10" x 3.5"  
270274

**BC8**  
Poly Hub  
8" x 2.5"  
270275

## Wheels



**R2**  
Poly Hub  
8" x 1.625"  
Moldon Rubber Tire  
054046

**R3**  
Aluminum Offset  
Hub  
8" x 1.625"  
Moldon Rubber Tire  
054048

**R1**  
Steel Offset Hub  
8" x 2.5"  
Semi-Pneumatic Tire  
220352

**Z**  
Steel Offset Hub  
10" x 2.75"  
Semi-Pneumatic Tire  
054047

**Z2**  
Poly Offset Hub  
10" x 2.75"  
Solid Rubber Tire  
054230

# Design it with Wesco® Cobra-Lite Components

## Here's how to design your truck...

From the previous page, choose the following components:  
**HANDLE, FRAME, NOSEPLATE and WHEEL**

Then from the bottom of this page, choose your **OPTIONS**:

**EXAMPLE:**

41 + 0 + T18 + R3 + F3 + S4K =  
410-T18-R3-F3-S4K



## Options

### Stair Glide & Climber Options



Deluxe cast aluminum stair glides  
**S2K**: without wearstrip  
220349  
**S3K**: with wearstrip  
220351



**S4K**  
Steel stair glides with wearstrips 220340  
Field Install Kit  
S4F #054237  
Factory Install



**S5K**  
Continuous belt stair climbers 220339  
(For 8" wheel only)  
Field Install Kit  
S5F #054236  
Factory Install

### Extension Options



Top extension for 40R, 40B, 41 and 45 handles  
**44UK** - 44" top extension  
220347  
**52UK** - 52" top extension  
220080  
**60UK** - 60" top extension  
220081  
**68UK** - 68" top extension  
220094  
(Vinyl coated top extensions available - see price list)

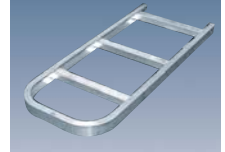

Folding nose extension  
20" long  
**F2** - For Cast Noses  
220346  
**F2E** - For Extruded Noses  
220082  
30" long  
**F3** - For Cast Noses  
220343  
**F3E** - For Extruded Noses  
220083

### Brake Options



**BCK**  
Continuous handle  
220354



**BPK**  
Pin handle 220355



**BTK**  
Twin handle 220356



**BDK**  
Loop handle 220357

### Custom Side Strips



Promote your company and products with personalized side strips. Ask your dealer for details.

### Strap

**CS** Center strap option  
054062 for "T" series noseplates  
054205 for "E" series noseplates



# Wesco® Cobra aluminum convertible trucks



## Higher Capacity Convertible Trucks 1,200 lbs.

### Features for Cobra Jr and Sr:

- 18" wide noseplate for large loads.
- Smooth and easy transition from the 2 to 4 wheeled position.
- Non-marking 5" x 1.25" swivel casters.
- 8 rivets per cross brace. Welded release pedal.
- Custom advertising side strips available – contact dealer for details.
- 2" wide cross braces for added strength and advertising labels.

### Cobra Jr and Sr Wheel Choices

#### Cobra Jr

##### Features:

- Dual hand grips for improved control.
- 3 frame cross braces.
- 12 inch x 38 inch frame bed.

As shown:  
CBR-JR-T18-PE



Hub: Dimensions: Wheel Type:	PWT Steel Offset 10" x 3.5" Pneumatic	PE Steel Offset 10" x 3.5" Pneumatic	Z Steel Offset 10" x 2.75" Semi-Pneumatic	Z2 Poly Offset 10" x 2.75" Solid Rubber
T18 NOSE Part # Model #	220293* CBR-JR-T18-PWT	220291* CBR-JR-T18-PE	220295* CBR-JR-T18-Z	220297* CBR-JR-T18-Z2
E18 NOSE Part # Model #	220482* CBR-JR-E18-PWT	220494* CBR-JR-E18-PE	220486* CBR-JR-E18-Z	220490* CBR-JR-E18-Z2
E16 NOSE Part # Model #	220483* CBR-JR-E16-PWT	220495* CBR-JR-E16-PE	220487* CBR-JR-E16-Z	220491* CBR-JR-E16-Z2
Capacity 2 Wheel	600 lbs	600 lbs	600 lbs	600 lbs
Capacity 4 Wheel	1,200 lbs	1,200 lbs	1,200 lbs	1,200 lbs
Overall Height	51.75"	51.75"	51.75"	51.75"
Frame Bed	12" x 38"	12" x 38"	12" x 38"	12" x 38"
Approximate Weight	39 lbs	37.5 lbs	43.5 lbs	42.5 lbs

LOOK

#### Cobra Sr

##### Features:

- Continuous handle allows multiple ways to control load.
- 4 frame cross braces.
- 12 inch x 50.75 inch frame bed.

As shown:  
CBR-SR-T18-PE



T18 NOSE Part # Model #	220292* CBR-SR-T18-PWT	220290* CBR-SR-T18-PE	220294* CBR-SR-T18-Z	220296* CBR-SR-T18-Z2
E18 NOSE Part # Model #	220484* CBR-SR-E18-PWT	220496* CBR-SR-E18-PE	220488* CBR-SR-E18-Z	220492* CBR-SR-E18-Z2
E16 NOSE Part # Model #	220485* CBR-SR-E16-PWT	220497* CBR-SR-E16-PE	220489* CBR-SR-E16-Z	220493* CBR-SR-E16-Z2
Capacity 2 Wheel	600 lbs	600 lbs	600 lbs	600 lbs
Capacity 4 Wheel	1,200 lbs	1,200 lbs	1,200 lbs	1,200 lbs
Overall Height	61.75"	61.75"	61.75"	61.75"
Frame Bed	12" x 50.75"	12" x 50.75"	12" x 50.75"	12" x 50.75"
Approximate Weight	42.5 lbs	41 lbs	47 lbs	46 lbs

LOOK

#### Options

- Platform Deck: Slip resistant diamond pattern surface for both cast and extruded noseplates.
- Folding Nose Kit.
- Coated handle.



Folding Nose

Part #	20" for T-18 noseplates	20" for E-18 and E-16 noseplates	30" for T-18 noseplates	30" for E-18 and E-16 noseplates
Part #	220346	220082	220343	220083
Model #	F2	F2E	F3	F3E



Platform Deck

Part #	220288	220289	220318	220514
Model #	SRD	JRD	SRDE	JRDE
Weight	10 lbs	8 lbs	10 lbs	8 lbs
Length	55"	42"	55"	42"
For Use With	Sr/Cast Noseplate	Jr/Cast Noseplate	Sr/Extruded Noseplate	Jr/Extruded Noseplate



# Wesco® 3 position truck, Mini Cobra and Spartan



## 3 Position Truck

### Features:

- Patent Number 6,364,328B1.
- Same strong, light-weight construction as the Cobra Jr.
- Quickly converts from 2-wheel to ergonomic tilt-back position or platform truck.
- 3 frame cross braces.
- 12 inch x 38 inch frame bed.
- T-18 nose.



Hub: Dimensions: Wheel Type:	PE Steel Offset 10" x 3.5" Pneumatic	PWT Steel Offset 10" x 3.5" Pneumatic	Z Steel Offset 10" x 2.75" Semi-Pneumatic
Part #	220591	220593	220594
Capacity 2 Wheel	500 lbs	500 lbs	500 lbs
Capacity 4 Wheel	650 lbs	650 lbs	650 lbs
Overall Height	52"	52"	52"
Weight	43 lbs	43 lbs	48 lbs

## Mini Cobra

### Features:

- U.S Patent No. 6,234,497B1.
- Unique patented design allows user to fold nose for storage.
- 8.25 inch x 32.25 inch frame bed.



Part #	220615
Wheels	Two 8" pneumatic Two 4" Jarvis Advantage non-marking casters
Overall Height	44"
Dimensions 2 Wheel	15" w x 16" d x 44" h
Dimensions 4 Wheel	15" w x 16" d x 29.5" h
Capacity 2 Wheel	300 lbs
Capacity 4 Wheel	500 lbs
Weight	28 lbs

## Spartan Economy Aluminum 2 in 1 Trucks

### Features:

- Sturdy, lightweight aluminum frame.
- 18" wide noseplate for large loads.
- Extra strength noseplate cast from special aluminum alloy.
- 10" full pneumatic wheel.
- Non-marking 5" x 1.25" swivel casters.
- Pedal release allows easy conversion from 2-wheel to 4-wheel position.
- Shipped K.D. in box



220001

Economically priced

LOOK →

	Spartan Jr.	Spartan Sr.
Part #	220000	220001
Model #	SPTN-T18-PE-JR	SPTN-T18-PE-SR
Capacity 2 wheel	500 lbs	500 lbs
Capacity 4 wheel	1,000 lbs	1,000 lbs
Overall Height	52"	61.5"
Frame Bed	12" x 38"	12" x 51"
Weight	37.5 lbs	41 lbs



220000

**NEW Higher Capacities**

# Wesco® heavy duty steel appliance & vending trucks

## Features:

- Welded frame and handles for maximum strength.
- Non-marking grey vinyl on all contact surfaces securely mounted to truck.
- Bolted holding dog assembly for easy interchange of parts.
- 2" wide heavy duty web belt is standard on all models.
- WESCO continuous belt stair climbers standard on all models.
- Various belt tightener options to meet your moving needs.

## Wheel Choices

### Wesco Steel Vending Truck

#### L-1 Features:

- Dual handle control.
- Large pneumatic wheels for rough terrain.
- Welded steel frame.
- One piece belt.
- 47" from noseplate to center of belt



#### Vending Truck

P12  
Steel Offset  
12" x 4"  
Pneumatic



Part #	230020
Model #	L-1
Capacity	700 lbs
Ratchet	None
Belt	one piece
Height	55"
Weight	62 lbs

### Wesco Steel Appliance Trucks

#### Features:

- All joints double welded for maximum durability.
- Rugged tubular steel construction.
- Available with "Auto-Rewind", "Manual", or "Eccentric" belt tightening systems.
- Aluminum center moldon rubber wheels with .625" ball bearings.
- 750 lb capacity.
- 26.5" from noseplate to center of belt

#### Super Wheel

- 10" pneumatic rear wheels.
- Quick and easy turnbuckle mounting system.
- Converts a 2 wheel truck into a 4 wheel truck.



A	R
Aluminum 6" x 2" Moldon Rubber	Aluminum 8" x 1.625" Moldon Rubber



Part #	230010	230011
Model #	WRC	WRC-R
Ratchet	Auto Rewind	Auto Rewind
Belt	2 piece clasp	2 piece clasp
Weight	52 lbs	53 lbs

Part #	230028	230029
Model #	WRC-EC	WRC-EC-R
Ratchet	Manual	Manual
Belt	One Piece	One Piece
Weight	52 lbs	53 lbs

Part #	Model #
Super Wheel 270075	SSWK

Look →



# Wesco® heavy duty steel appliance & vending trucks

## Wesco Steel Vending Machine Trucks

### Features:

- Retractable moldon rubber casters (3.5" diameter) help support load.
- Heavy duty 8" cast iron center moldon rubber wheels with roller bearings.
- Available with "Auto-Rewind" or "Economy" belt tightening systems.
- 1,200 lb capacity.
- 28.5" from noseplate to center of belt.



	Manual Ratchet	Auto Rewind Ratchet
Part #	230035	230017
Model #	WRV-60-EC	WRV-60
Height	60"	60"
Belt	one piece	two piece clasp
Weight	83 lbs	83 lbs
Part #	230036	230018
Model #	WRV-66-EC	WRV-66
Height	66"	66"
Belt	one piece	two piece clasp
Weight	86 lbs	86 lbs
Part #	230037	230019
Model #	WRV-72-EC	WRV-72
Height	72"	72"
Belt	one piece	two piece clasp
Weight	95 lbs	95 lbs

# Wesco® magnesium vending truck

## Wesco Magnesium Vending Machine Trucks

### Features:

- Foot pedal release for casters allow operator to open and close them while standing up-right.
- Retractable moldon rubber casters (3.5" diameter) help support load.
- Welded magnesium frame, noseplate and handles - A Wesco Exclusive.
- Magnesium is 33% lighter than aluminum and is the lightest structural metal.
- Manual belt tightening system.
- Continuous belt stairclimbers are standard.
- 29" from noseplate to center of belt.



## Wheel Choice

	A Aluminum 6" x 2" Moldon Rubber
Part #	230038
Model #	MRV-60-EC
Capacity	750 lbs
Ratchet	manual
Belt	one piece
Height	60"
Weight	57 lbs
Part #	230040
Model #	MRV-66-EC
Capacity	750 lbs
Ratchet	manual
Belt	one piece
Height	66"
Weight	59 lbs

# Wesco® magnesium appliance trucks

## Wesco Magnesium Appliance Trucks

### Features:

- Magnesium Frame, Noseplate and Handles - A Wesco Exclusive.
- Magnesium is 33% lighter than aluminum and is the world's lightest structural metal.
- Fully welded frame and handles for maximum strength and durability.
- Available with "Auto-Rewind", or "Manual" belt tightening systems.
- 500 to 750 LB. Capacities.
- MRC Trucks, 30.5" from noseplate to center of belt.
- M2RC Trucks, from noseplate to center of lower belt 29.5" and 50.5" to center of top belt.

### Options:

#### Super Wheel

(for magnesium appliance trucks only)

- 10" pneumatic rear wheels for easy handling on rough terrain.
- Quick and easy turnbuckle mounting system.
- Converts a 2 wheel truck into a 4 wheel truck.

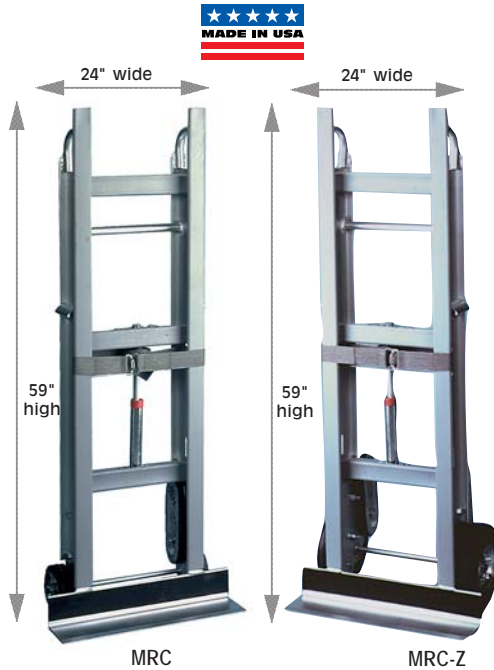

MRC

MRC-Z

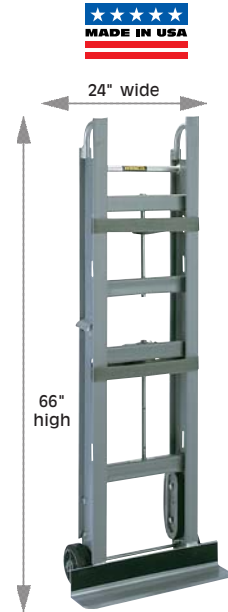

M2RC-66-EC

## Wheel Choices

	A Aluminum 6" x 2" Moldon Rubber	R Aluminum 8" x 1.625" Moldon Rubber	Z Steel Offset 10" x 2.75" Semi-Pneumatic	PWT Steel Offset 10" x 3.5" Pneumatic
Part #	230001	230002	230004	230005
Model #	MRC	MRC-R	MRC-Z	MRC-PWT
Capacity	750 lbs	750 lbs	500 lbs	600 lbs
Ratchet	auto rewind	auto rewind	auto rewind	auto rewind
Belt	2 piece w/clasp	2 piece w/clasp	2 piece w/clasp	2 piece w/clasp
Height	59"	59"	59"	59"
Weight	37 lbs	46 lbs	53 lbs	49 lbs
Part #	230030	230031	230032	230033
Model #	MRC-EC	MRC-EC-R	MRC-EC-Z	MRC-ECPWT
Capacity	750 lbs	750 lbs	500 lbs	600 lbs
Ratchet	manual	manual	manual	manual
Belt	one piece	one piece	one piece	one piece
Height	59"	59"	59"	59"
Weight	35 lbs	46 lbs	52 lbs	49 lbs
Part #	230008	230009	-	-
Model #	M2RC-66-EC	M2RC-66-EC-R	-	-
Capacity	750 lbs	750 lbs	-	-
Ratchet	(2) manual	(2) manual	-	-
Belt	(2) one piece	(2) one piece	-	-
Height	66"	66"	-	-
Weight	41 lbs	51 lbs	-	-



	Part #	Model #
Super Wheel	270076	MSWK



# Wesco® **StairKing** battery powered stair climbing appliance truck

## Features:

- **PATENT PENDING**
- 1/2 Horsepower, 50 amp, high torque motor runs cooler under load and gets over **80% more lifts** per charge.
- Industrial grade gear box transmits steady power and is preferable to other drive designs.
- Large 2" diameter, polyurethane lifting feet provide more secure stair gripping.
- Auto rewind ratchet works first to take the slack out of the cargo belt, and then provides a ratchet crank to securely tighten the load.
- Noseplate measures 24" by 4" deep.
- Sealed maintenance-free battery. Charger and circuit breaker included.
- Welded magnesium frame and noseplate.
- 6" mold-on rubber wheels.
- 30" from noseplate to center of belt.



Patent Pending



Available in two heights: 66" and 72"

Model	Part	Weight	Capacity	Dimensions		
				Width	Height	Depth
DC-66	230051	101 lbs	850 lbs	19"	66"	15"
DC-72	230052	102 lbs	850 lbs	19"	72"	15"

# Wesco® **StairKing** battery powered stair climbing appliance truck options



Optional aluminum winch lift attachment has 800 lb capacity. 3-1/2" Jarvis Advantage® swivel casters for 4 wheel support and mobility. Winch equipped with autobraking system. 18" forks, adjustable width up to 19" outside dimension. 57.25" lift height. *Factory or field installation.*

Model #	Part #	Weight	Capacity	Dimensions		
				Width	Height	Depth
Aluminum winch lift attachment*						
WLF	230053	67 lbs	800 lbs	25 "	70 "	30 "
Steel nose extension						
NE-28	230055	18 lbs	-	28 "	4 "	12 "
Steel slip on platform						
SP-20	260160	20 lbs	-	20 "	7 "	20 "
Superwheel option						
MSWK	270076	19 lbs	-	11.5 "	4.5 "	20.5 "
Kick-out wheel						
KOW	230059	9 lbs	850 lbs	-	-	-
Cigarette lighter charger						
BC	230060	2 lbs	-	-	-	-

\*can be factory or field installed

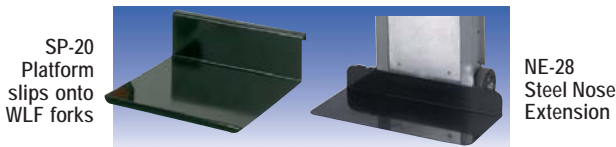

Toe plate extension. Easily clips on to standard toe plate and provides 12" deep x 28" wide cargo surface.

Platform attachment. Slides in place over winch lift forks to provide a 20" x 20" lifting platform.

## Stair climbing, battery powered appliance truck component details

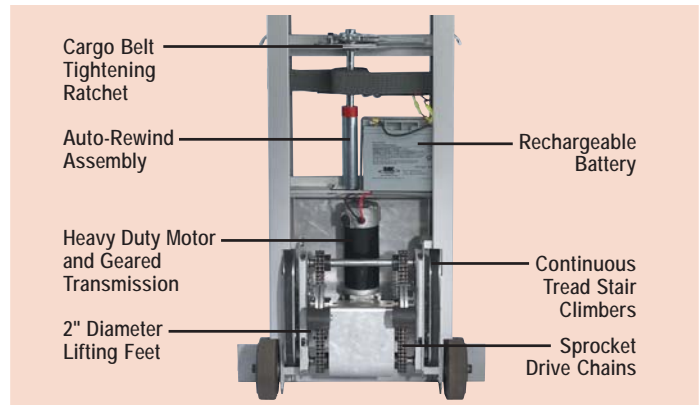

**Superwheel attachment** installs in seconds. Equipped with 10" x 4" full pneumatic tires. Provides 4 wheel support and eases transport over rough surfaces.



**KOW** Kick-Out 3.5" casters for four wheel stability.



**BC** Charge battery while driving between stops. Plugs into cigarette lighter. Cable length 20'.

# Wesco® deluxe pallet trucks

Deluxe Models feature **5 year pump warranty** and **5,500 lb. capacity** plus

- Pump overload bypass. ■ Rubber coated handle. ■ Adjustable fork tie rods. ■ Exit rollers
- 200° steering. ■ Tapered fork tips. ■ 8 gauge 6" wide reinforced forks.

## Deluxe Adjustable Fork Model

### Features:

- 7" moldon polyurethane steering wheel.
- 3" moldon polyurethane load wheels.
- 7.75" raised height.
- 3" lowered height.
- US Patent No. 6,540,241.
- 6" wide forks.



**A Wesco exclusive**

**One truck to do the work of two**

Adjustable fork width can be set from 21" to 27" or anywhere in between. Just loosen and reset front and rear adjusting bolts.

### Deluxe Adjustable Fork Model

Part #	Fork width x length	Weight	Capacity
272744	21"-27" x 46"	180 lbs	5,500 lbs

## Standard Deluxe Models

### Features:

- 8" moldon polyurethane steering wheel.
- 3" moldon polyurethane load wheels.
- 8" raised height.
- 3" lowered height.
- 6" wide forks.

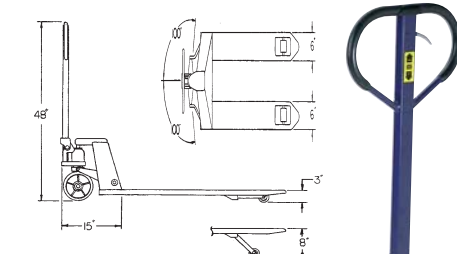

### Standard Deluxe Models

Part #	Fork width x length	Weight	Capacity
272136	21" x 36"	143 lbs	5,500 lbs
272142	21" x 42"	152 lbs	5,500 lbs
272148	21" x 48"	157 lbs	5,500 lbs
272736	27" x 36"	151 lbs	5,500 lbs
272742	27" x 42"	161 lbs	5,500 lbs
272748	27" x 48"	166 lbs	5,500 lbs

## Deluxe Lowboy Models

### Features:

- 6" moldon polyurethane steering wheel.
- 2" steel load wheels.
- 6.25" raised height.
- 2.125" lowered height.
- 6" wide forks.

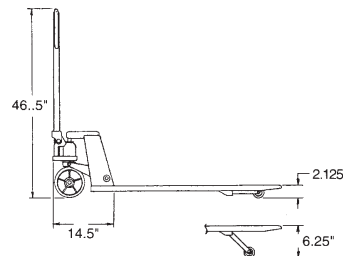

### Deluxe Lowboy Models

Part #	Fork width x length	Weight	Capacity
272760	21" x 36"	134 lbs	5,500 lbs
272761	21" x 42"	143 lbs	5,500 lbs
272762	21" x 48"	148 lbs	5,500 lbs
272765	27" x 48"	157 lbs	5,500 lbs

## Deluxe Foot Pump Model

### Features:

- All the same features and dimensions as Standard Deluxe Model 272748.
- 6" wide forks.

### Deluxe Foot Pump Model

Part #	Fork width x length	Weight	Capacity
272766	27" x 48"	170 lbs	5,500 lbs

**Look Foot Pump**

Patent pending foot pedal gives you the option of using the foot pedal to raise the forks when space constraints make it difficult to use the standard handle to raise the load.

**NO EXTRA COST**

# Wesco® 3 in 1 guard adapter



The **Patent Pending 3 in 1 Guard** is three products in one compact design. You no longer need to purchase separate milk crate guards, box guards or skid adapters. Wesco's 3 in 1 guard does it all.

## Features:

- **Patent Pending** design.
- Fits only Wesco 27" x 48" CPI pallet truck #272660.
- Easily attaches to Wesco CPI pallet truck.
- Factory or field installed.



PATENT PENDING

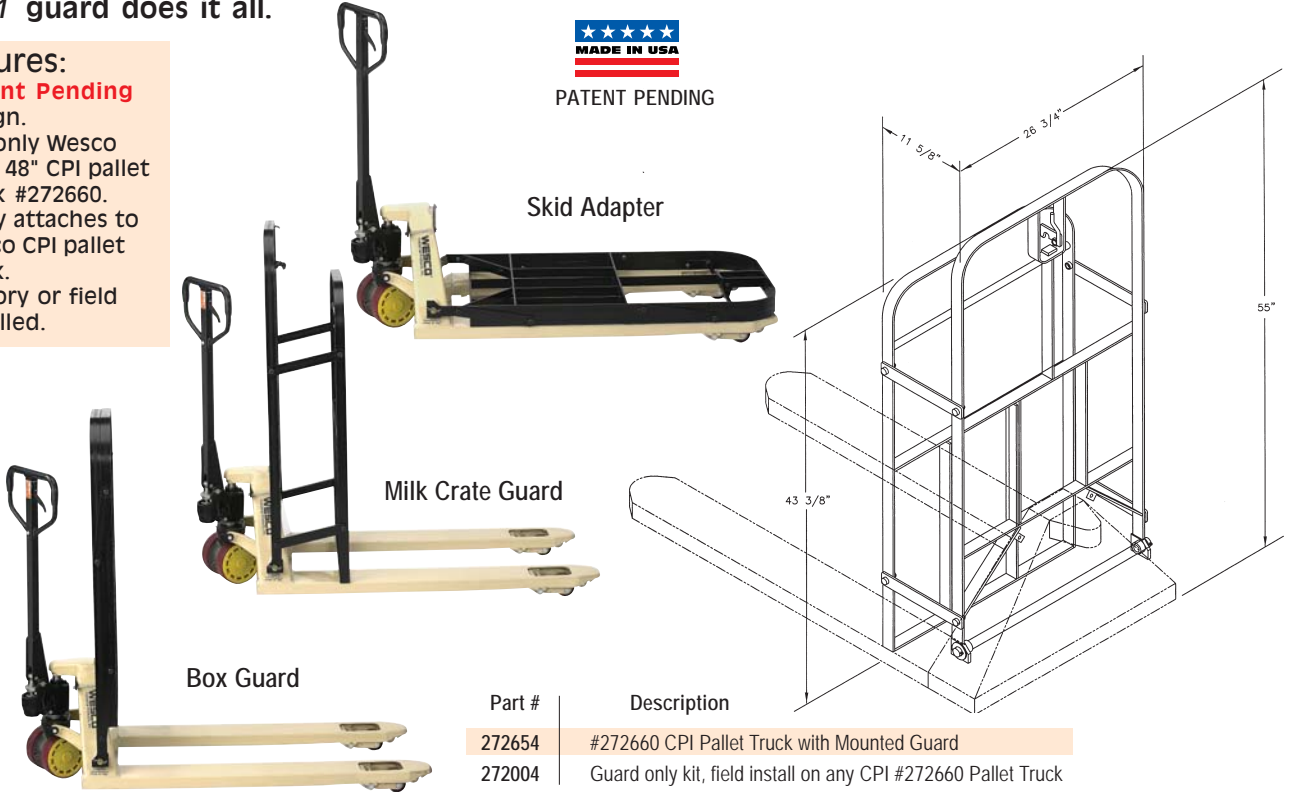

Part #	Description
272654	#272660 CPI Pallet Truck with Mounted Guard
272004	Guard only kit, field install on any CPI #272660 Pallet Truck

# Wesco® CPI pallet trucks

## CPI Economy Pallet Truck

### Features:

- Adjustable fork connecting rods.
- Overload bypass.
- Rubber coated handle.
- Raised height: 7.25"  
lowered height: 2.9"
- **2 year pump warranty.**
- 6" wide forks.
- 7" moldon polyurethane steering wheels.
- 3" moldon polyurethane load wheels.



6" Wide Forks

272660

Part #	Fork width x length	Weight	Capacity
272655	21" x 36"	168 lbs	5,500 lbs
272656	21" x 42"	180 lbs	5,500 lbs
272657	21" x 48"	189 lbs	5,500 lbs
272658	27" x 36"	195 lbs	5,500 lbs
272659	27" x 42"	205 lbs	5,500 lbs
272660	27" x 48"	196 lbs	5,500 lbs



# Wesco® CII pallet trucks

## CPII Pallet Truck

### Features:

- Polyurethane or nylon wheels.
- Adjustable fork connecting rods.
- Entry/exit rollers.
- Overload bypass.
- Reinforced forks.
- Rubber coated handle.
- Raised height: 8" lowered height: 3"
- **3 year pump warranty.**
- 7" wide forks.
- 8" moldon polyurethane or nylon steering wheels.
- 3" moldon polyurethane or nylon load wheels.



7" Wide Forks

272778

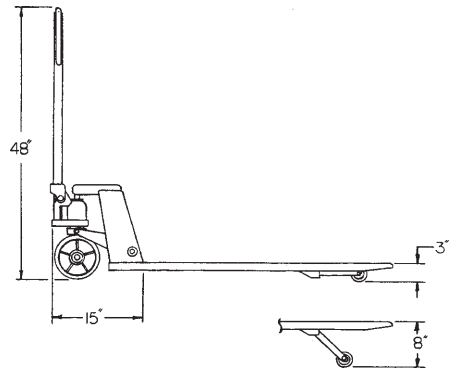

Polyurethane Wheels			
Part #	Fork width x length	Weight	Capacity
272777	21" x 48"	200 lbs	5,500 lbs
272778	27" x 48"	203 lbs	5,500 lbs

Nylon Wheels			
Part #	Fork width x length	Weight	Capacity
272775	21" x 48"	200 lbs	5,500 lbs
272776	27" x 48"	210 lbs	5,500 lbs

## CPII Lowboy Pallet Truck

### Features:

- Many features are the same as CPII.
- Lowered height of 2.125".
- **3 year pump warranty.**
- 7" wide forks.
- 7" moldon polyurethane steering wheels.
- 2" steel load wheels.

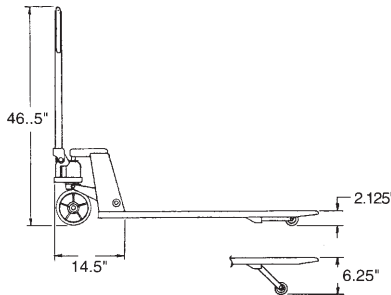

CPII Lowboy			
Part #	Fork width x length	Weight	Capacity
278136	21" x 36"	226 lbs	4,400 lbs
278142	21" x 42"	235 lbs	4,400 lbs
278148	21" x 48"	240 lbs	4,400 lbs
278748	27" x 48"	249 lbs	4,400 lbs

## CPIIHD Pallet Truck

### Features:

- Adjustable fork connecting rods.
- Entry/exit rollers.
- Overload bypass.
- Reinforced forks.
- Rubber coated handle.
- Raised height: 8" lowered height: 3"
- **3 year pump warranty.**
- 7" wide forks.
- 8" moldon polyurethane steering wheels.
- 3" moldon polyurethane load wheels.



7" Wide Forks

CPII, Heavy-Duty Model			
Part #	Fork width x length	Weight	Capacity
272670	27" x 48"	220 lbs	6,600 lbs

Look



# Wesco® pallet trucks

## Pallet Truck with Hand Brake

### Features:

- All the same features as the CPI model.
- 5,500 lb. capacity
- **2 year pump warranty.**
- 6" wide forks.
- 7" moldon polyurethane steering wheels.
- 3" moldon polyurethane load wheels.



**Look  
Brake**



Part #	272667
Fork width x length	27" x 48"
Weight	215 lbs
Capacity	5,500 lbs



## Scale Truck

### Features:

- Weighing accuracy ± .22 lbs., or 3.5 oz.
- LCD display scale.
- Metler-Toledo Hawk scale/sensor.
- UL approved scale operates on six D cell batteries or AC.
- **Charge rechargeable type "D" size batteries without removing from display.**
- Charging time, from 0 to full charge, 40 minutes
- Three position hand control.
- 205° turning radius.
- **2 year pump warranty.**
- 7" wide forks.
- 7" moldon polyurethane steering wheels.
- 3" moldon polyurethane load wheels.



**LOOK** →

Part #	272936	272938
Model #	SPT27	SPT22
Fork width x length	27.5" x 47.5"	22" x 47.5"
Weight	307 lbs	300 lbs
Capacity	5,000 lbs	5,000 lbs
Lowered fork height	2.9"	2.9"
Raised fork height	8"	8"



**NEW & IMPROVED  
Wesco Exclusive**

Charge rechargeable type "D" size batteries without removing from display.

# Wesco® High Lifts Telescoping & Non-Telescoping

## Electric High Lift

### Features:

- Two models: Telescoping and Non-Telescoping.
- 12 volt battery - charger included.
- 10-12 second lift time unloaded.
- Overload bypass.
- Polyurethane wheels.
- 180° steering radius.
- Comfort coated handles.
- 1 year pump warranty.
- 6 1/2" wide forks.
- 6" moldon polyurethane steering wheels.
- 3" moldon polyurethane load wheels.



	Part #	272939	272937	292460	272461
	Model #	TEHL21	TEHL27	NTEHL21	NTEHL27
Fork width x length		21" x 45"	27" x 45"	21" x 45"	27" x 45"
Weight		315 lbs	322 lbs	367 lbs	372 lbs
Capacity		3,000 lbs	3,000 lbs	2,200 lbs	2,200 lbs
Lowered fork height		3.3"	3.3"	3.3"	3.3"
Raised fork height		31"	31"	31"	31"
Telescoping		Yes	Yes	No	No

## Manual High Lift

### Features:

- Two models: Telescoping and Non-Telescoping.
- Moldon polyurethane wheels.
- 180° steering arc.
- Loop handles with inside hand control.
- Closed pallets must be placed on top of forks.
- 1 year pump warranty.
- 6 1/2" wide forks.
- 6" moldon polyurethane steering wheels.
- 3" moldon polyurethane load wheels.



	Part #	272755	272754	262462	272463
	Model #	TSHL21	TSHL27	NTSHL21	NTSHL27
Fork width x length		21" X 44.5"	27" X 44.5"	21" x 44.5"	27" x 44.5"
Weight		219 lbs	228 lbs	275 lbs	300 lbs
Capacity		2,200 lbs	2,200 lbs	2,200 lbs	2,200 lbs
Lowered fork height		3.6"	3.6"	3.3"	3.3"
Raised fork height		31.5"	31.5"	31.5"	31.5"
Telescoping		Yes	Yes	No	No

# Wesco® pallet trucks

## Ergonomic pallet tilter

### Features:

- Capacity: 2200lbs.
- 5" polyurethane swivel casters and 3" polyurethane load wheels.
- Handle height: 44 1/4".
- Load center: min. 7 1/2", max. 15 1/2".
- Lifting range with forks in horizontal position: 3 1/4 to 11".
- Forks tilt up to 90° for accurate load positioning.
- Lifting range with back rest in horizontal position (forks tilted upwards to 90°): 29 to 37".
- 6 1/2" wide forks.
- 1 year pump warranty



Part #	Fork width x length	Weight	Capacity
272950	21.5" x 31"	393 lbs	2,200 lbs

## Tandem wheel pallet truck

### Features:

- Adjustable fork connecting rods.
- Overload bypass.
- Rubber coated handle.
- Raised height: 7.25"  
lowered height: 2.9"
- **2 year pump warranty.**
- 6 1/2" wide forks.
- 7" moldon polyurethane steering wheels.
- 3" moldon polyurethane load wheels.



**Look**   
**Tandem Load  
Wheels**

Part #	Fork width x length	Weight	Capacity
272668	21" x 48"	205 lbs	5,500 lbs
272669	27" x 48"	215 lbs	5,500 lbs



Tandem Load Wheels



## Pallet Lifter

### Features:

- Heavy duty steel construction.
- Pallets with bottom boards must be placed on top of forks.
- 1 year pump warranty.
- 6 1/2" wide forks.
- 6" polyurethane swivel casters.
- 2" polyurethane load wheels.



Part #	272153
Fork width x length	27" x 44"
Weight	172 lbs
Capacity	1,100 lbs
Lowered height	3.2"
Raised height	35"

## Stainless Steel Pallet Truck

### Features:

- All parts are made of stainless.
- For use in food industry and areas where corrosive solutions are used.
- 1 year pump warranty.
- 6 1/4" wide forks.
- 7" nylon steering wheels.
- 3" nylon load wheels.



Part #	272152
Fork width x length	27" x 48"
Weight	172 lbs
Capacity	4,400 lbs
Lowered fork height	3.35"
Raised fork height	8"

## TransRoller Pallet Truck

### Features:

- Lowered height 3.4". Raised height 8.5".
- Fork height in standard mode 3.4" lowered, 7" raised.
- Fork height for lateral movement 7.25" lowered, 8.5" raised.
- Adjustable fork connecting rods.
- Overload bypass.
- Ergonomic rubber-coated handle.
- Entry rollers.
- **3 year pump warranty.**
- 7" wide forks.
- 8" moldon polyurethane steering wheels.
- 3" moldon polyurethane load wheels.



Unique side rolling pallet truck with one year pump warranty

Part #	Fork width x length	Weight	Capacity Standard Mode	Capacity Lateral Mode
272740	27" x 48"	206 lbs	5,000 lbs	2,200 lbs

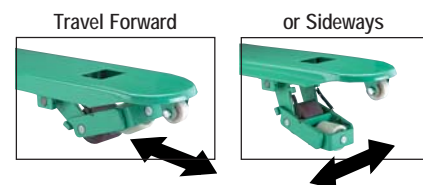

# Wesco® steel frame pedalifts

## Steel frame pedalifts features:

- 750 lb lift capacity.
- Wheel locks are standard on all models.
- Frame and lift heights vary among models.

### Two Wheeled Winch Models

#### Features:

- Auto-brake designed winch raises and lowers by turning handle, - no catches to lock or release required.
- Low maintenance design.
- Front of platform touches the ground on two wheeled model.
- Wheel lock standard.
- All 54" lifts are 60.5" O.A.H.
- All 40" lifts are 48.5" O.A.H.
- 750 lb capacity.

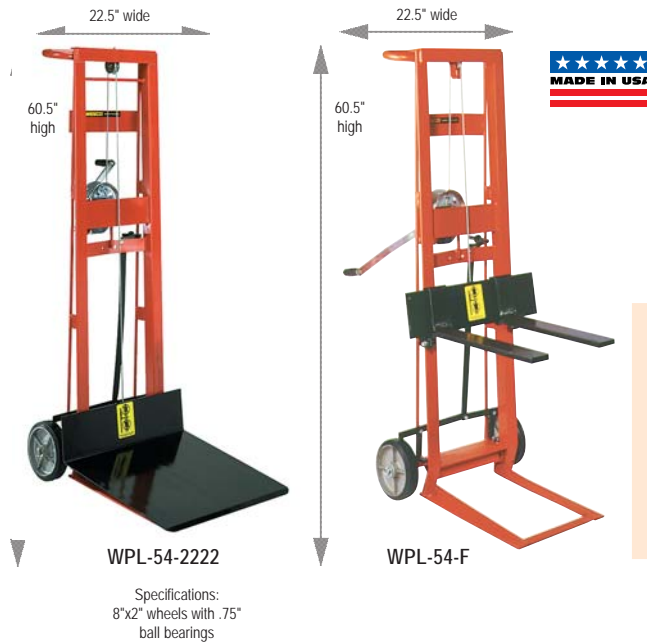

	Platform Models	Fork Models
Part #	260015	260018
Model #	WPL-40-1620	WPL-40-F
Lift Height	40"	40"
Platform/Fork size	16"D x 20"W	18"D x 3"W
Weight	106 lbs	125 lbs
Capacity	750 lbs	750 lbs
Part #	260016	260019
Model #	WPL-54-2222	WPL-54-F
Lift Height	54"	54"
Platform/Fork size	22"D x 22"W	18"D x 3"W
Weight	147 lbs	157 lbs
Capacity	750 lbs	750 lbs
Part #	260017	
Model #	WPL-54-2230	
Lift Height	54"	
Platform/Fork size	22"D x 30"W	
Weight	157 lbs	
Capacity	750 lbs	

### Four Wheeled Winch Models

#### Features:

- Winch allows easy horizontal storage and transportation.
- Low maintenance design.
- Platform on four wheeled model sits 5.75" above the floor.
- Wheel lock standard.
- All 54" lifts are 60.5" O.A.H.
- All 40" lifts are 48.5" O.A.H.
- 750 lb capacity.



	Platform Models	Fork Models
Part #	260020	260023
Model #	WDPL-40-1620	WDPL-40-F
Lift Height	40"	40"
Platform/Fork size	16"D x 20"W	18"D x 3"W
Weight	113 lbs	132 lbs
Capacity	750 lbs	750 lbs
Part #	260021	260024
Model #	WDPL-54-2222	WDPL-54-F
Lift Height	54"	54"
Platform/Fork size	22"D x 22"W	18"D x 3"W
Weight	153 lbs	163 lbs
Capacity	750 lbs	750 lbs
Part #	260022	
Model #	WDPL-54-2230	
Lift Height	54"	
Platform/Fork size	22"D x 30"W	
Weight	163 lbs	
Capacity	750 lbs	

# Wesco® steel frame pedalifts

## Two Wheeled Hydraulic Models

### Features:

- Front tip of nose plate touches floor.
- Foot operated hydraulic pump raises platform, foot release lowers platform.
- Wheel lock standard.
- All 54" lifts are 60.5" O.A.H.
- All 40" lifts are 48.5" O.A.H.
- 750 lb capacity.



	Platform Models	Fork Models
Part #	260001	260006
Model #	PL-40-1620	PL-40-F
Lift Height	40"	40"
Platform/Fork size	16"D x 20"W	18"D x 3"W
Weight	112 lbs	131 lbs
Capacity	750 lbs	750 lbs
Part #	260002	260007
Model #	PL-54-2222	PL-54-F
Lift Height	54"	54"
Platform/Fork size	22"D x 22"W	18"D x 3"W
Weight	156 lbs	166 lbs
Capacity	750 lbs	750 lbs
Part #	260003	-
Model #	PL-54-2230	-
Lift Height	54"	-
Platform/Fork size	22"D x 30"W	-
Weight	166 lbs	-
Capacity	750 lbs	-

## Four Wheeled Hydraulic Models

### Features:

- Foot operated hydraulic pump raises platform, foot release lowers platform.
- Platform sits 5.75" above the floor.
- Wheel lock standard.
- All 54" lifts are 60.5" O.A.H.
- All 40" lifts are 48.5" O.A.H.
- 750 lb capacity.



	Platform Models	Fork Models
Part #	260008	260011
Model #	DPL-40-1620	DPL-40-F
Lift Height	40"	40"
Platform/Fork size	16"D x 20"W	18"D x 3"W
Weight	119 lbs	138 lbs
Capacity	750 lbs	750 lbs
Part #	260009	260012
Model #	DPL-54-2222	DPL-54-F
Lift Height	54"	54"
Platform/Fork size	22"D x 22"W	18"D x 3"W
Weight	162 lbs	172 lbs
Capacity	750 lbs	750 lbs
Part #	260010	-
Model #	DPL-54-2230	-
Lift Height	54"	-
Platform/Fork size	22"D x 30"W	-
Weight	172 lbs	-
Capacity	750 lbs	-

# Wesco® Universal, Cylinder & Lite-Lifts

## Universal lift

### Features:

- Two straps with buckles to help secure load, 9' wrap around & 5' front to back.
- Winch with auto brake.
- Two 8" wheels and two 3 1/2" polyurethane casters.
- Lowered platform sits 6" above ground.
- Ideal for placing rental equipment on to pickup truck or into van.

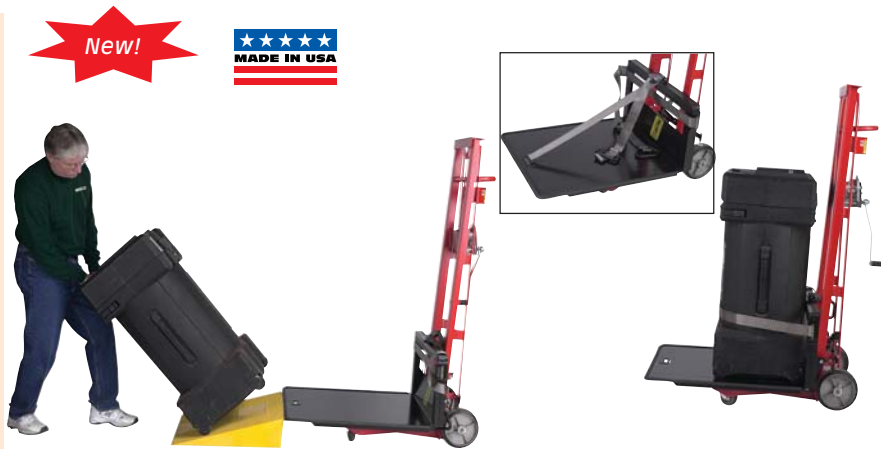

Part #	260130
Model #	ULP2630
Lift Height	54"
Overall Height	60.5"
Weight	224 lbs
Capacity	750 lbs
Platform	26"W x 30"L

## Cylinder lift

### Features:

- Easily lifts and transports gas cylinders.
- Capacity 300 lbs.
- Swivel casters make maneuvering in tight places easier.
- Foot operated hydraulic pump or manual winch with auto-brake available.



Part #	260161	260163
Model #	LLHPB	LLWPB
Lift Height	40"	40"
Overall Height	52"	58"
Weight	165 lbs	150 lbs
Capacity	300 lbs	300 lbs
Type	Hydraulic	Winch

LLHPB shown

## Hydraulic lite-lift

### Features:

- Foot operated hydraulic pump.
- Release foot pedal for controlled lowering.
- Small skid/engine lifter available.



LLHP  
width 20"  
height 70.5"

LLWP  
width 20"  
height 70.5"

LLHF

HYDRAULIC UNITS		
	Platform	Forks
Part #	260150	260151
Model #	LLHP	LLHF
Lift Height	54"	54"
Overall Height	70.5"	70.5"
Weight	139 lbs	157 lbs
Capacity	500 lbs	500 lbs

## Winch lite-lift

### Features:

- Manual winch with auto-brake.
- No catches to release.
- Low maintenance.

## Platform option

### Features:

- Provides the utility of two units.
- Easy installation - no tools required.

Platform option for fork units

To order option add part # or model to Lite-Lift part # or model.

WINCH UNITS		
	Platform	Forks
Part #	260152	260153
Model #	LLWP	LLWF
Lift Height	54"	54"
Overall Height	70.5"	70.5"
Weight	103 lbs	124 lbs
Capacity	500 lbs	500 lbs
		Platform Option
Part #	260157	
Model #	POK	



# Wesco® magnesium frame pedalifts

## Magnesium frame Pedalifts features:

- Magnesium construction for lightweight ruggedness.
- 20" deep x 22" wide platform size.
- Wheel locks are standard on all models.
- 400 lb capacity.
- Front of platform touches the floor.
- Frame and lift heights vary among models.

### Two Wheeled Winch Models

#### Features:

- Auto-brake designed winch raises and lowers by turning handle, - no catches to lock or release.
- Light weight minimizes the effort required for moving and lifting.
- Wheel lock standard.
- All 54" lifts are 60.5" O.A.H. All 40" lifts are 48.5" O.A.H.



WMPL-54-2022  
Winch/Platform  
Specifications:  
8"x2" wheels with  
.75" ball bearings

Two Wheeled Model	
Part #	260025
Model #	WMPL-40-2022
Lift Height	40"
Weight	53 lbs
Capacity	400 lbs

Part #	260026
Model #	WMPL-54-2022
Lift Height	54"
Weight	60 lbs
Capacity	400 lbs

### Two Wheeled Hydraulic Models

#### Features:

- Foot operated hydraulic pump raises platform, foot release lowers platform.
- Wheel lock standard.
- All 54" lifts are 60.5" O.A.H. All 40" lifts are 48.5" O.A.H.



MPL-54-2022  
Specifications:  
8"x2" wheels with .75" ball bearings

Two Wheeled Platform Model	
Part #	260004
Model #	MPL-40-2022
Lift Height	40"
Weight	63 lbs
Capacity	400 lbs

Part #	260005
Model #	MPL-54-2022
Lift Height	54"
Weight	69 lbs
Capacity	400 lbs

# Wesco® "S"tandard line and "E"conomy line platform model hydraulic stackers

## Hydraulic stackers features:

- 1000 lb lift capacity.
- Floor locks, safety screen and foot guard are standard on all models.
- Forks touch the floor on all fork models.
- Front phenolic wheels are 5" diameter.
- Rear phenolic swivel casters are 4" diameter.
- Hydraulic jack manufactured by WESCO in U.S.A.
- Frame and lift heights vary among models.
- "S"tandard line features one piece platform guide rail.
- "E"conomy line offers an economical price value.

### Wesco Platform Models

#### Features:

- 24" x 24" heavy gauge platform with 5.75" lowered height.
- 15" load center.
- 25.5" overall width, 40" depth.
- Base leg span - 15" inside, 21" outside.
- 1,000 lb capacity.



### Wesco Large Platform Models

#### Features:

- 30" deep x 32" wide heavy gauge platform with 5.25" lowered height.
- 18" load center.
- 32" overall width, 44" depth.
- Base leg span - 25.5" inside, 32" outside.
- 1,000 lb capacity.



### PLATFORM MODELS

	Standard	Economy
Part #	260032	260044
Model #	SPL-60-2424	ESPL-60-2424
Lift Height	60"	60"
Overall Height	75"	72"
Weight	233 lbs	226 lbs
Capacity	1,000 lbs	1,000 lbs

	Standard	Economy
Part #	260033	260045
Model #	SPL-68-2424	ESPL-68-2424
Lift Height	68"	68"
Overall Height	83"	80"
Weight	241 lbs	234 lbs
Capacity	1,000 lbs	1,000 lbs

	Standard	Economy
Part #	260034	260046
Model #	SPL-80-2424	ESPL-80-2424
Lift Height	80"	80"
Overall Height	94"	92"
Weight	274 lbs	263 lbs
Capacity	1,000 lbs	1,000 lbs

### LARGE PLATFORM MODELS

	Standard	Economy
Part #	260038	260050
Model #	SPL-60-3032	ESPL-60-3032
Lift Height	60"	60"
Overall Height	75"	72"
Weight	272 lbs	265 lbs
Capacity	1,000 lbs	1,000 lbs

	Standard	Economy
Part #	260039	260051
Model #	SPL-68-3032	ESPL-68-3032
Lift Height	68"	68"
Overall Height	83"	80"
Weight	282 lbs	273 lbs
Capacity	1,000 lbs	1,000 lbs

	Standard	Economy
Part #	260040	260052
Model #	SPL-80-3032	ESPL-80-3032
Lift Height	80"	80"
Overall Height	94"	92"
Weight	317 lbs	298 lbs
Capacity	1,000 lbs	1,000 lbs

# Wesco® "S"tandard line and "E"conomy line fork model hydraulic stackers

## Fork Model

### Features:

- 1" thick x 3" wide x 25" long forks.
- Adjustable span up to 25".
- 15" load center.
- 25.5" overall width; 40" depth.
- Base leg span - 15" inside, 21" outside.
- Forks lower to ground.
- 1,000 lb capacity.



## FORK MODELS

	Standard	Economy
Part #	260035	260047
Model #	SFL-56-25	ESFL-56-25
Lift Height	56"	56"
Overall Height	75"	72"
Weight	265 lbs	258 lbs
Capacity	1,000 lbs	1,000 lbs

Part #	260036	260048
Model #	SFL-64-25	ESFL-64-25
Lift Height	64"	64"
Overall Height	83"	80"
Weight	273 lbs	266 lbs
Capacity	1,000 lbs	1,000 lbs

Part #	260037	260049
Model #	SFL-76-25	ESFL-76-25
Lift Height	76"	76"
Overall Height	94"	92"
Weight	306 lbs	295 lbs
Capacity	1,000 lbs	1,000 lbs

## Straddle Fork Model

### Features:

- 1" thick x 3" wide x 30" long forks.
- Adjustable span up to 25".
- 18" load center.
- 32" overall width; 44" depth.
- Base leg span - 25.5" inside, 32" outside.
- Forks lower to ground.
- 1,000 lb capacity.



## STRADDLE FORK MODELS

	Standard	Economy	Wide
Part #	260041	260053	260075
Model #	SFL-56-30S	ESFL-56-30S	ESFL-56-30-42S
Lift Height	56"	56"	56"
Overall Height	75"	72"	72.5"
Weight	288 lbs	281 lbs	290 lbs
Capacity	1,000 lbs	1,000 lbs	1,000 lbs

Part #	260042	260054	-
Model #	SFL-64-30S	ESFL-64-30S	-
Lift Height	64"	64"	-
Overall Height	83"	80"	-
Weight	298 lbs	289 lbs	-
Capacity	1,000 lbs	1,000 lbs	-

Part #	260043	260055	-
Model #	SFL-76-30S	ESFL-76-30S	-
Lift Height	76"	76"	-
Overall Height	94"	92"	-
Weight	333 lbs	322 lbs	-
Capacity	1,000 lbs	1,000 lbs	-

## Wide Straddle Fork Model

### Features:

- Base leg span - 42" inside, 48.75" outside.
- 1" thick by 3" wide by 30" long forks adjustable span.
- Overall width 48.75", depth 48.25".
- Forks lower to the ground.
- 1,000 lb capacity.



# Wesco® stackers

## 1,000 lb capacity winch stacker

### Features:

- Heavy duty 1,000 lb capacity.
- Heavy duty winch with auto brake.



Part #	270214
Model #	SWPL-68-2424
Lift Height	70"
Overall Height	83.25"
Weight	239 lbs
Capacity	1,000 lbs
Platform Size	24" x 24"

## Value lift

### Features:

- 880 lb capacity.
- Two styles - forks or platform.
- Adjustable width forks 24" long x 4 1/4" wide.
- Optional, removable chrome plated 23" wide x 24" deep platform.
- Foot operated hydraulic pump.
- Two 5" polyurethane swivel casters with brakes, and two 3" rigid polyurethane wheels.
- Two lifting height models: 47" and 59".
- Chrome plated rails and handle.



Adjustable Fork Model



The chrome plated platform is an option.

With optional platform

	Value Lift	Value Lift	Optional Platform
Part #	272940	272941	272942
Model #	VL44	VL59	VLRP
Lift Height	3 1/2" - 47"	3 1/2" x 59"	-
Weight	178 lbs	187 lbs	10 lbs
Overall Dimensions	22 1/2"W x 36"D x 55"H	22 1/2"W x 37"D x 70"H	23"W x 24"D
Capacity	880 lbs	880 lbs	-
Lifting Forks	Standard	Standard	-

## Manual and Electric Office Lifts

### Features:

- Ideal for narrow aisles.
- Great for offices.
- Two models, manual and electric.
- Lightweight, but sturdy.
- Sealed battery and automatic charger built in.
- Remote up and down pendant for electric model.



MOL

EOL

	Manual	Electric
Part #	272467	272468
Model #	MOL	EOL
Lowered Height	5"	5"
Raised Height	58.5"	66"
Weight	104 lbs	146 lbs
Platform Size	18" x 23"	18" x 23"
Capacity	220 lbs	220 lbs



# Wesco® powered stackers 1,000 lb. capacity

## Powered stacker features:



- **Meets ASME B56.10 specifications.**
- **1,000 to 2,000 lb. lift capacity.**
- **Remote control, floor lock, and safety screen are standard on all models.**
- **With a minimally charged battery, unit can be used while recharging.**
- **Three light LED charge status indicator – no extra cost!**
- **Easy to read illuminated battery status voltmeter – no extra cost!**
- **12V DC battery or 110V AC units available.**

## COUNTER-BALANCED FORK MODELS

Part #	261037	261038	261039
Model #	PCBFL-56-25	PCBFL-64-25	PCBFL-76-25
Lift Height	56"	64"	76"
Overall Height	72"	80"	92"
Weight	522 lbs	530 lbs	559 lbs
Capacity	1,000 lbs	1,000 lbs	1,000 lbs
Load Center	13"	13"	13"

Counterweights are not included and must be installed prior to use.

Order Required Counterweight Kit for your load.

Part #	261041	261042	261043
Counterweight	200 lbs	400 lbs	600 lbs
Stacker Load Capacity	334 lbs	668 lbs	1000 lbs

## Counter-Balance Model

### Features

- Loading and unloading trucks.
- Positioning dies.
- Feeding material to presses.
- 25" long forks.
- Order enough weight kits for your planned load. (See chart at right)

Note:

Counter-Balance Stackers require appropriate counterweights. See chart at right.

- **AC models not available**



261039

Standard features include: voltmeter, remote control, 3 light charger and on/off switch



## Platform Model

### Features:

- 24" x 24" or 30" x 32" platform size L x W.
- 5" phenolic wheels on front, 4" phenolic swivel casters on rear.

- **110V AC models available. To order add AC to the end of the battery powered stacker part #.**  
Example:  
Battery Powered #261024  
110V AC Powered #261024AC



261024

## PLATFORM MODELS

Part #	261022	261023	261024
Model #	PESPL-60-2424	PESPL-68-2424	PESPL-80-2424
Lift Height	60"	68"	80"
Overall Height	72"	80"	92"
Weight	418 lbs	428 lbs	457 lbs
Leg ID/OD	15"/21"	15"/21"	15"/21"
Capacity	1,000 lbs	1,000 lbs	1,000 lbs
Load Center	15"	15"	15"

Part #	261025	261026	261027
Model #	PESPL-60-3032	PESPL-68-3032	PESPL-80-3032
Lift Height	60"	68"	80"
Overall Height	72"	80"	92"
Weight	457 lbs	467 lbs	492 lbs
Leg ID/OD	25.5"/32"	25.5"/32"	25.5"/32"
Capacity	1,000 lbs	1,000 lbs	1,000 lbs
Load Center	18"	18"	18"

# Wesco® powered stackers

## Fork Model

### Features:

- Forks lower to floor on all models.
- 5" phenolic wheels on front, 4" swivel on rear.
- **110V AC models available. To order add AC to the end of the battery powered stacker part #.**  
*Example:*  
*Battery Powered #261033*  
*110V AC Powered #261033AC*



261033

## FORK MODELS

Part #	261028	261029	261030
Model #	PESFL-56-25	PESFL-64-25	PESFL-76-25
Lift Height	56"	64"	76"
Overall Height	72"	80"	92"
Weight	452 lbs	460 lbs	489 lbs
Leg ID/OD	15"/21"	15"/21"	15"/21"
Capacity	1,000 lbs	1,000 lbs	1,000 lbs
Load Center	15"	15"	15"

## STRADDLE FORK MODELS

Part #	261031	261032	261033
Model #	PESFL-56-30S	PESFL-64-30S	PESFL-76-30S
Lift Height	56"	64"	76"
Overall Height	72"	80"	92"
Weight	475 lbs	483 lbs	519 lbs
Leg ID/OD	25.5"/32"	25.5"/32"	25.5"/32"
Capacity	1,000 lbs	1,000 lbs	1,000 lbs
Load Center	18"	18"	18"



## Adjustable Span Straddle Model

### Features

- Extra deep (40") straddle legs and forks for lifting pallets.
- Versatile adjustable span straddle legs can be set from 34" to 50" inside dimension to handle most standard pallets.
- **110V AC models available. To order add AC to the end of the battery powered stacker part #.**  
*Example:*  
*Battery Powered #261035*  
*110V AC Powered #261035AC*



261035

## ADJUSTABLE STRADDLE FORK MODELS

Part #	261034	261035	261036
Model #	PASFL-56-40S	PASFL-64-40S	PASFL-76-40S
Lift Height	56"	64"	76"
Overall Height	72"	80"	92"
Weight	510 lbs	518 lbs	554 lbs
Straddle legs I.D.	34" to 50"	34" to 50"	34" to 50"
Capacity	1,000 lbs	1,000 lbs	1,000 lbs
Load Center	20"	20"	20"

# Wesco® telescoping powered stackers

## Wesco® 1,500 and 2,000 lb capacity powered telescoping fork stackers

- Meets ASME B56.10 specifications.
- Instant carriage stop for accuracy- no drifting.
- Adjustable forks.
- Heavy duty rigid frame and base.
- Double chain lift for better balance and load support.
- Heavy-duty pump.
- Ergonomic "D" handles.
- High strength mast for increased stability.
- Optional 5th wheel for easier overall mobility and turning in confined areas.
- 110V AC models available. To order add AC to the end of the battery powered stacker part #.

Example:

Battery Powered #261118

110V AC Powered #261118AC

Easily adjustable legs



### TELESCOPING MODELS – FIXED WIDTH BASE – 2,000 LB CAPACITY

Part #	Model #	Lift Range	Overall Height	Weight Lbs.	Capacity Lbs.	Load Center	Fork Size D x W x L	Outside Fork Spread	Base Leg ID/OD
261120	PTSFL-96-42-42S-2K	1.5"-96"	70.5"	1,210	2,000	24"	1.5" x 3" x 42"	7.4"-30"	42"/48"
261119	PTSFL-130-42-42S-2K	1.5"-130"	87.5"	1,280	2,000	24"	1.5" x 3" x 42"	7.4"-30"	42"/48"
261124	PTSFL-96-42-50S-2K	1.5"-96"	70.5"	1,210	2,000	24"	1.5" x 3" x 42"	7.4"-30"	50"/56"
261123	PTSFL-130-42-50S-2K	1.5"-130"	87.5"	1,280	2,000	24"	1.5" x 3" x 42"	7.4"-30"	50"/56"

### TELESCOPING MODELS – ADJUSTABLE WIDTH BASE - 1,500 AND 2,000 LB CAPACITY

Part #	Model #	Lift Range	Overall Height	Weight Lbs.	Capacity Lbs.	Load Center	Fork Size D x W x L	Outside Fork Spread	Base Leg ID/OD
261117	PTASFL-96-42-3550S-1.5K	1.5"-96"	70.5"	1,230	1,500	24"	1.5" x 3" x 42"	7.4"-30"	35"-50" ID Adj.
261118	PTASFL-130-42-3550S-1.5K	1.5"-130"	87.5"	1,300	1,500	24"	1.5" x 3" x 42"	7.4"-30"	35"-50" ID Adj.
261115	PTASFL-96-42-3550S-2K	1.5"-96"	70.5"	1,230	2,000	24"	1.5" x 3" x 42"	7.4"-30"	35"-50" ID Adj.
261116	PTASFL-130-42-3550S-2K	1.5"-130"	87.5"	1,300	2,000	24"	1.5" x 3" x 42"	7.4"-30"	35"-50" ID Adj.

5th Wheel Steering Option  
For easier mobility and precision steering in confined areas

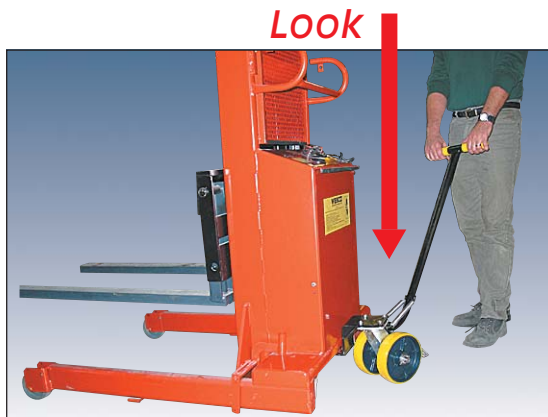

Available for all 1,500 and 2,000 lb models.  
8" locking polyurethane wheels. Spring loaded handle.  
Can be field installed.  
Order as separate option under Part # 261099

# Wesco® 1,500 & 2,000 lb. powered stacker



## ADJUSTABLE FORK MODELS

Part #	Model #	Lift Height	Overall Height	Weight lbs	Capacity lbs	Load Center	Fork Width/Length	Base Leg ID/OD
261079	PSFL-56-25-15S-1.5K	56"	72"	474	1,500	15"	3"/25"	15"/21"
261080	PSFL-64-25-15S-1.5K	64"	83"	488	1,500	15"	3"/25"	15"/21"
261081	PSFL-76-25-15S-1.5K	76"	94"	544	1,500	15"	3"/25"	15"/21"
261082	PSFL-86-25-15S-1.5K	86"	104"	585	1,500	15"	3"/25"	15"/21"
261083	PSFL-56-25-20S-1.5K	56"	72"	485	1,500	15"	3"/25"	20"/26"
261084	PSFL-64-25-20S-1.5K	64"	83"	499	1,500	15"	3"/25"	20"/26"
261085	PSFL-76-25-20S-1.5K	76"	94"	555	1,500	15"	3"/25"	20"/26"
261086	PSFL-86-25-20S-1.5K	86"	104"	596	1,500	15"	3"/25"	20"/26"
261092	PSFL-56-25-20S-2K	56"	72"	490	2,000	15"	3"/25"	20"/26"
261093	PSFL-64-25-20S-2K	64"	83"	514	2,000	15"	3"/25"	20"/26"
261094	PSFL-76-25-20S-2K	76"	94"	559	2,000	15"	3"/25"	20"/26"
261095	PSFL-86-25-20S-2K	86"	104"	601	2,000	15"	3"/25"	20"/26"
261059	PSFL-64-30-30S-1.5K	64"	83"	522	1,500	18"	3"/30"	30"/36"
261060	PSFL-76-30-30S-1.5K	76"	94"	578	1,500	18"	3"/30"	30"/36"
261061	PSFL-86-30-30S-1.5K	86"	104"	619	1,500	18"	3"/30"	30"/36"
261044	PSFL-64-30-30S-2K	64"	83"	527	2,000	18"	3"/30"	30"/36"
261045	PSFL-76-30-30S-2K	76"	94"	583	2,000	18"	3"/30"	30"/36"
261046	PSFL-86-30-30S-2K	86"	104"	624	2,000	18"	3"/30"	30"/36"
261062	PSFL-64-42-42S-1.5K	64"	83"	527	1,500	24"	3"/42"	42"/48"
261063	PSFL-76-42-42S-1.5K	76"	94"	585	1,500	24"	3"/42"	42"/48"
261064	PSFL-86-42-42S-1.5K	86"	104"	630	1,500	24"	3"/42"	42"/48"
261047	PSFL-64-42-42S-2K	64"	83"	533	2,000	24"	3"/42"	42"/48"
261048	PSFL-76-42-42S-2K	76"	94"	590	2,000	24"	3"/42"	42"/48"
261049	PSFL-86-42-42S-2K	86"	104"	635	2,000	24"	3"/42"	42"/48"
261065	PSFL-64-42-50S-1.5K	64"	83"	533	1,500	24"	3"/42"	50"/56"
261066	PSFL-76-42-50S-1.5K	76"	94"	590	1,500	24"	3"/42"	50"/56"
261067	PSFL-86-42-50S-1.5K	86"	104"	635	1,500	24"	3"/42"	50"/56"
261050	PSFL-64-42-50S-2K	64"	83"	538	2,000	24"	3"/42"	50"/56"
261051	PSFL-76-42-50S-2K	76"	94"	595	2,000	24"	3"/42"	50"/56"
261052	PSFL-86-42-50S-2K	86"	104"	640	2,000	24"	3"/42"	50"/56"
261068	PASFL-64-42-3550S-1.5K	64"	83"	543	1,500	24"	3"/42"	35"-50" ID ADJ.
261069	PASFL-76-42-3550S-1.5K	76"	94"	600	1,500	24"	3"/42"	35"-50" ID ADJ.
261070	PASFL-86-42-3550S-1.5K	86"	104"	645	1,500	24"	3"/42"	35"-50" ID ADJ.
261053	PASFL-64-42-3550S-2K	64"	83"	548	2,000	24"	3"/42"	35"-50" ID ADJ.
261054	PASFL-76-42-3550S-2K	76"	94"	605	2,000	24"	3"/42"	35"-50" ID ADJ.
261055	PASFL-86-42-3550S-2K	86"	104"	650	2,000	24"	3"/42"	35"-50" ID ADJ.

## 1,500 & 2,000 lb Capacity Powered Stackers

- Meets ASME B56.10 specifications.
- Adjustable base legs available on fork models.
- Fixed platforms 24 x 24, 24 x 27, 30 x 32.
- Reinforced frame and base.
- Double chain, lift support.
- Heavy-duty pump.
- Ergonomic "D" handles.
- 5th wheel option see page 65
- 110V AC models available. To order add AC to the end of the battery powered stacker part #. Example:  
Battery Powered #261055  
110V AC Powered #261055AC



## FIXED PLATFORM MODELS

Part #	Model #	Lift Height	Overall Height	Weight lbs	Capacity lbs	Load Center	Platform L x W	Base Leg ID/OD
261074	PSPL-60-2424-15S-1.5K	60"	72"	428	1,500	15"	24" x 24"	15"/21"
261075	PSPL-68-2424-15S-1.5K	68"	83"	436	1,500	15"	24" x 24"	15"/21"
261076	PSPL-80-2424-15S-1.5K	80"	94"	469	1,500	15"	24" x 24"	15"/21"
261077	PSPL-90-2424-15S-1.5K	90"	104"	502	1,500	15"	24" x 24"	15"/21"
261088	PSPL-60-2427-20S-2K	60"	72"	435	2,000	15"	24" x 27"	20"/26"
261089	PSPL-68-2427-20S-2K	68"	83"	441	2,000	15"	24" x 27"	20"/26"
261090	PSPL-80-2427-20S-2K	80"	94"	476	2,000	15"	24" x 27"	20"/26"
261091	PSPL-90-2427-20S-2K	90"	104"	508	2,000	15"	24" x 27"	20"/26"
261071	PSPL-60-3032-30S-1.5K	60"	72"	438	1,500	18"	30" x 32"	30"/36"
261072	PSPL-68-3032-30S-1.5K	68"	83"	446	1,500	18"	30" x 32"	30"/36"
261073	PSPL-80-3032-30S-1.5K	80"	94"	480	1,500	18"	30" x 32"	30"/36"
261078	PSPL-90-3032-30S-1.5K	90"	104"	512	1,500	18"	30" x 32"	30"/36"
261056	PSPL-60-3032-30S-2K	60"	72"	443	2,000	18"	30" x 32"	30"/36"
261057	PSPL-68-3032-30S-2K	68"	83"	451	2,000	18"	30" x 32"	30"/36"
261058	PSPL-80-3032-30S-2K	80"	94"	485	2,000	18"	30" x 32"	30"/36"
261087	PSPL-90-3032-30S-2K	90"	104"	517	2,000	18"	30" x 32"	30"/36"



# Wesco® foot pump hydraulic lift tables



## Wesco Standard Duty Tables (200 - 1,000 lb Capacities)

- Features:**
- LT-02-1616 has four 3" polyolefin swivel casters.
  - LT-02-1616 ships via UPS knocked down.
  - LT-05 and LT-10 models feature 2 rigid and 2 swivel 4" phenolic resin roller bearing casters.
  - 7 Gauge steel top and base.
  - 3/8" lift per stroke.



## Features:

- Capacity ranges from 200 to 6,000 lbs.
- Solid steel top and base construction.
- Floor locks are standard on all 500 lb.+ capacity tables.
- Casters provide easy mobility.



LT-02-1616



LT-05-1818

	200 lb Capacity	500 lb Capacity	1,000 lb Capacity
Part #	260059	260060	260061
Model #	LT-02-1616	LT-05-1818	LT-10-1836
Weight	54 lbs	122 lbs	168 lbs
Table Size	16" x 16"	18" x 18"	18" x 36"
Lowered Height	28.5"	30.5"	30.5"
Raised Height	46"	47.5"	47.5"
Support Posts	None	Two	Two
Caster Size	3"	4"	4"

## Wesco Medium & Heavy Duty Tables (2,000-6,000 lb Capacities)

- Features:**
- 2 rigid and 2 swivel 6" phenolic resin roller bearing casters.
  - LTL models feature 4" casters and 3/8" lift per stroke.
  - LT models feature 6" casters.
  - Four support posts and push handle.
  - Foot operated floor lock.

### 2,000 lb Capacity

	260062	260063
Part #	260062	260063
Model #	LTL-20-2436	LTL-20-3248
Weight	225 lbs	350 lbs
Table Size	24" x 36"	32" x 48"
Lowered Height	30.5"	30.5"
Raised Height	47.5"	47.5"
Support Posts	Four	Four
Caster Size	4"	4"

### 4,000 lb Capacity

	260066	260067
Part #	260066	260067
Model #	LT-40-2436	LT-40-3248
Weight	325 lbs	475 lbs
Table Size	24" x 36"	32" x 48"
Lowered Height	37"	37"
Raised Height	59"	59"
Support Posts	Four	Four
Caster Size	6"	6"



LT-60-2436

### 2,000 lb Capacity

	260064	260065
Part #	260064	260065
Model #	LT-20-2436	LT-20-3248
Weight	320 lbs	465 lbs
Table Size	24" x 36"	32" x 48"
Lowered Height	37"	37"
Raised Height	59"	59"
Support Posts	Four	Four
Caster Size	6"	6"

### 6,000 lb Capacity

	260068	260069
Part #	260068	260069
Model #	LT-60-2436	LT-60-3248
Weight	330 lbs	495 lbs
Table Size	24" x 36"	32" x 48"
Lowered Height	37"	37"
Raised Height	59"	59"
Support Posts	Four	Four
Caster Size	6"	6"

# Wesco® powered lift tables



## Powered Lift Tables

### Features:

- Up to 6,000 lbs capacity.
- Standard floor lock holds table steady for loading and unloading.
- Easy to read illuminated battery status voltmeter.
- Three light LED battery charge status indicator.
- With a minimally charged battery, unit can be used while recharging.

**LOOK** → Remote control for raising/lowering. Magnets on back of remote allow for storage anywhere on table.



Part #	261108	261100	261101	261102	261103	261104	261105	261106	261107
Model #	PLT-10-1836	PLTL-20-2436	PLTL-20-3248	PLT-20-2436	PLT-20-3248	PLT-40-2436	PLT-40-3248	PLT-60-2436	PLT-60-3248
Table Size	18" x 36"	24" x 36"	32" x 48"	24" x 36"	32" x 48"	24" x 36"	32" x 48"	24" x 36"	32" x 48"
Lowered Ht	30.5"	30.5"	30.5"	37"	37"	37"	37"	37"	37"
Raised Ht	47.5"	47.5"	47.5"	59"	59"	59"	59"	59"	59"
Caster Size	4"	4"	4"	6"	6"	6"	6"	6"	6"
Capacity	1,000 lbs	2,000 lbs	2,000 lbs	2,000 lbs	2,000 lbs	4,000 lbs	4,000 lbs	6,000 lbs	6,000 lbs
Weight	280 lbs	337 lbs	462 lbs	432 lbs	577 lbs	437 lbs	587 lbs	442 lbs	607 lbs

# Wesco® value lift tables



### Features:

- Polyurethane casters, 2 rigid, 2 swivel.
- Foot operated pump and release.
- Ships KD.



272470



272469

Part #	272469	272470
Model #	VLT200	VLT500
Weight	76 lbs	153 lbs
Table Size	16" x 16"	18" x 18"
Lowered Height	29"	30"
Raised Height	46"	48"
Support Posts	None	Two
Caster Size	3"	4"
Floor Lock	No	Yes

# Wesco® scissor lift tables

## Light Duty Scissor Lift Tables

### Features:

- Capacity 330 lbs.
- Chrome plated handle and foot pedal.
- Lever release handle.
- 4" x 1" moldon polyurethane wheels with locking swivel casters.
- Folding handle lays flat on table top.
- Foot operated pump.



LT-330SL

Part #	260201
Model #	LT-330SL
Capacity	330 lbs
Raised Height	28.5"
Lowered Height	8.5"
Unit Weight	98 lbs
Table Top L x W	27.5 x 17.75"
Overall Height	37"
Length	36"
Width	17.75"

## 700, 1000 lb Capacity

- Foot operated pump.
- Easy to use spring loaded release lever.
- 5" x 1.5" polyurethane casters with locks.



	Part # 260199	260200
Model #	LT-700SL	LT-1000SL
Weight	165 lbs	185 lbs
Table Size	19.5" x 32"	19.5" x 32"
Lowered Height	11"	11"
Raised Height	35"	35"
Capacity	700 lbs	1,000 lbs
Overall Height	37"	37"
Length	42"	42"
Width	19.5"	19.5"

## Double Scissors High Lift Table

### Features:

- Capacity 770 lbs.
- Chrome plated handle and foot pedal.
- Lever release handle.
- 5" x 1.5" moldon polyurethane wheels with locking swivel casters.
- Foot operated pump.
- Maximum raised height 55.5".



LT-770DSL

Part #	260204
Model #	LT-770DSL
Capacity	770 lbs
Raised Height	55.5"
Lowered Height	14"
Unit Weight	227 lbs
Table Top L x W	35.5 x 19.5"
Overall Height	55.5"
Length	45.5"
Width	19.5"

# Wesco® scissor lift tables

## 660 lb Capacity

### Features:

- Three position finger control—raising, neutral, lowering.
- Polyurethane load wheels with locking 5" x 1.5" swivel casters.
- 44.25" high handle for comfortable use.
- Foot guard standard.



LT-660SL



LT-660-FOSL

	Hand Operated	Foot Operated
Part #	272770	272769
Model #	LT-660SL	LT-660-FOSL
Weight	197 lbs	200 lbs
Table Size	19.5" x 32"	19.5" x 32"
Lowered Height	10.75"	10.75"
Raised Height	35"	35"
Capacity	660lbs.	660 lbs.
Overall Height	44.25"	44.25"
Length	38.75"	38.75"
Width	19.75"	19.75"

## Ergonomic Scissors Tilt Table

### Features:

- Allows operator to feed and unload parts from an ergonomic position.
- Foot activated hydraulic cylinder.
- As table is raised the top automatically tilts to a 45° angle at full elevation.
- Retaining lip keeps containers in place.
- Locking bars prevent accidental lowering of table.



Part #	Model #	Front Height		Rear Height		Capacity	Table Size W x L	Weight	Height to Engage Locking Bar	
		Min.	Max.	Min.	Max.				Front	Rear
272953	STT880	17"	40"	17"	63"	880 lbs	20" x 32"	271 lbs	31.5"	45.5"
272954	STT1760	17"	40"	17"	63"	1760 lbs	20" x 32"	320 lbs	31.5"	45.5"



# Wesco® gantry cranes

## Features:

- Available in manual adjust, lever adjust and fixed height models.
- Posts are heavy gauge square tubing construction.
- I-Beams are American standard.
- 4-position phenolic resin swivel lock casters for smooth straight line travel.
- Capacities up to 3 tons.

## Specifications:

- Overall length is 12' 6".
- Clearance between uprights is 11'4" maximum (adjustable).
- 6'6" overall depth.
- 6" x 2" wheels on 1 ton models.
- 8" x 2" wheels on 2 ton models.
- 8" x 2 1/2" wheels on 3 ton models.
- Adjustable gantries adjust in 6" increments.

Call or see price list for details on gantry without I-Beam.



Adjustable Beam Mounting System



LEVER ADJUSTED



### LEVER ADJUSTED height gantry cranes WITH I-BEAMS included:

	1 Ton Gantries	2 Ton Gantries	3 Ton Gantries
Part #	360009	360011	360013
Model #	GC-121-LI	GC-122-LI	GC-123-LI
Height Range	9' - 12'	9' - 12'	9' - 12'
I-Beam Height x Lbs./Ft.	8" x 18.4 lbs/ft	8" x 4"	10" x 25.4 lbs/ft
Weight	722 lbs	767 lbs	874 lbs
Part #	360010	360012	360014
Model #	GC-151-LI	GC-152-LI	GC-153-LI
Height Range	12' - 15'	12' - 15'	12' - 15'
I-Beam Height x Lbs./Ft.	8" x 18.4 lbs/ft	8" x 4"	10" x 25.4 lbs/ft
Weight	776 lbs	821 lbs	929 lbs

### MANUALLY ADJUSTED height gantry cranes WITH I-BEAMS included:

	1 Ton Gantries	2 Ton Gantries	3 Ton Gantries
Part #	360001	360003	360005
Model #	GC-121-MI	GC-122-MI	GC-123-MI
Height Range	9' - 12'	9' - 12'	9' - 12'
I-Beam Height x Lbs./Ft.	8" x 18.4 lbs/ft	8" x 4"	10" x 25.4 lbs/ft
Weight	709 lbs	754 lbs	862 lbs
Part #	360002	360004	360006
Model #	GC-151-MI	GC-152-MI	GC-153-MI
Height Range	12' - 15'	12' - 15'	12' - 15'
I-Beam Height x Lbs./Ft.	8" x 18.4 lbs/ft	8" x 23 lbs/ft	10" x 25.4 lbs/ft
Weight	764 lbs	809 lbs	915 lbs

### FIXED HEIGHT gantry cranes WITH I-BEAMS included:

	1 Ton Gantries	2 Ton Gantries
Part #	360007	360008
Model #	GC-101-FI	GC-102-FI
Height Range	10'	10'
I-Beam Height x Lbs./Ft.	8" x 18.4 lbs/ft	8" x 23 lbs/ft
Weight	620 lbs	665 lbs

# Wesco® chain hoists & trolleys

## Wesco Chain Hoists

### Features:

- High quality, economical hoists in capacities to 5 tons.
- Available in 10 and 20 foot lifts.
- Hardened load chain for long life.
- Low headroom for easy installation in tight areas.
- Lubrication free load brake for positive load control.
- Swivel hooks with latches on all models.
- Portable for easy use in a wide range of applications.



Part #	Capacity	Lift Height	Approx. weight	Distance hook to hook	Chain pull to lift rated load	Hand chain overhaul for 1' lift
272163	1,000 lbs	10'	19.5 lbs	9.5"	50 lbs	30'
272164	2,000 lbs	10'	24 lbs	10.6"	70 lbs	38'
272165	3,000 lbs	10'	35.5 lbs	13.75"	80 lbs	59'
272166	4,000 lbs	10'	33 lbs	15"	70.6 lbs	80'
272167	6,000 lbs	10'	52 lbs	18.5"	82.5 lbs	135'
272168	10,000 lbs	10'	81.5 lbs	23.6"	90 lbs	160'
272169	1,000 lbs	20'	31.5 lbs	9.5"	50 lbs	30'
272170	2,000 lbs	20'	35.5 lbs	10.6"	70 lbs	38'
272171	3,000 lbs	20'	52.5 lbs	13.75"	80 lbs	59'
272172	4,000 lbs	20'	50 lbs	15"	70.6 lbs	80'
272173	6,000 lbs	20'	76.5 lbs	18.5"	82.5 lbs	135'
272174	10,000 lbs	20'	117.5 lbs	23.6"	90 lbs	160'

## Wesco Trolleys

### Features:

- Heavy duty trolleys designed for flexibility of installation.
- Usable on straight or curved track.
- Adjusts for wide variety of beam widths; simply remove end nut and adjust spacers.
- Can be installed or removed from any point in the track.



Part #	Capacity	Fits I-Beam flange width	A	B	C	Approx. weight
272158	1,000 lbs	3.5" to 5.5"	4"	10.25"	7.875"	18 lbs
272159	2,000 lbs	3.5" to 5.875"	5"	12.5"	9.5"	31 lbs
272160	4,000 lbs	4.125" to 7"	5.75"	13.25"	11.375"	48 lbs
272161	6,000 lbs	4" to 7"	6.75"	14"	13.25"	76 lbs
272162	10,000 lbs	5" to 7"	7.75"	14.625"	15.375"	104 lbs

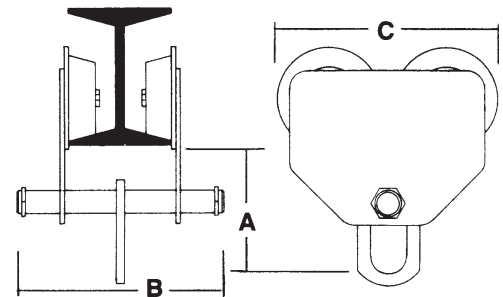

# Wesco® Rais-N-Rol™ machinery movers

## Features:

- Heavy duty capacities up to 5 tons - the most economical way to lift and move large bulky loads.
- Swivel casters allow movement in any direction.
- Hand operated hydraulic jack for easy lifting and controlled lowering of loads.
- All models supplied with hooks for recommended optional LB-1 or LB-2 load binders.

### 2,000 lb capacity per pair

#### Features:

- 23" wide x 12.5" deep x 48.375" high (lowered height).
- ID fork span range 7.25" to 17.5".

As shown: RNR-2



Part #	260086	260091
Model #	RNR-2	RNR-2P
Lift	5"	5"
Casters	5" x 2" Phenolic	5" x 2" Urethane
Weight	160 lbs/PR	167 lbs/PR

### 4,000 lb capacity per pair

#### Features:

- 23" wide x 16.5" x 43.625" high (lowered height).
- ID fork span range 5" to 19.5".

As shown: RNR-4

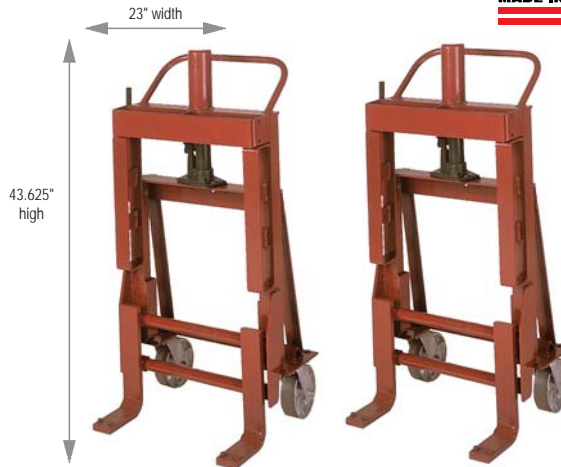

Part #	260087	260092
Model #	RNR-4	RNR-4P
Lift	12"	12"
Casters	6" x 2" Steel	6" x 2" Urethane
Weight	315 lbs/PR	313 lbs/PR

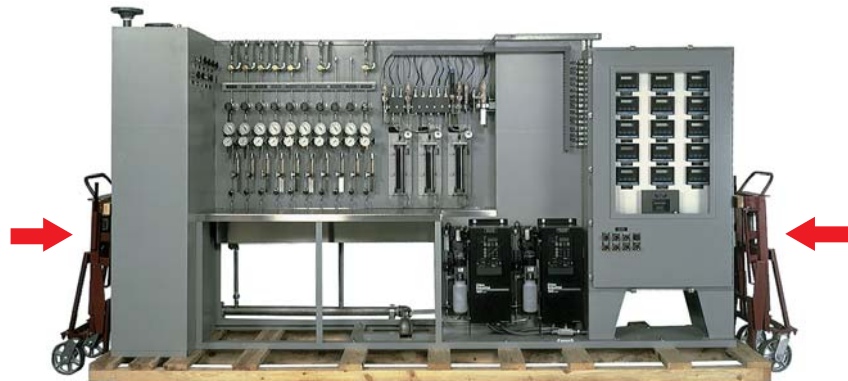

# Wesco® Rais-N-Rol™ machinery movers

## 6,000 lb capacity per pair

### Features:

- 23" wide x 16.5" deep.
- RNR-6(P): 41.375" H  
RNR-64(P): 43.625" H.
- ID fork span range 6" to 19.5".

As shown: RNR-6P



Part #	260088	260093	
Model #	RNR-6	RNR-6P	
Lift	6"	6"	
Casters	6" x 2.5" Steel	6" x 2.5" Urethane	
Weight	325 lbs/PR	306 lbs/PR	
Part #	260138	260139	
Model #	RNR-64	RNR-64P	
Lift	12"	12"	
Casters	6" x 2.5" Steel	6" x 2.5" Urethane	
Weight	359 lbs/PR	359 lbs/PR	

## 8,000 lb capacity per pair

### Features:

- 23" wide x 16.5" x 43.375" high (lowered height).
- ID fork span range 6" to 19.5".

As shown: RNR-8



Part #	260089	260094	
Model #	RNR-8	RNR-8P	
Lift	6"	6"	
Casters	8" x 2.5" Steel	8" x 2.5" Urethane	
Weight	390 lbs/PR	402 lbs/PR	

## 10,000 lb capacity per pair

### Features:

- 23" wide x 16.5" x 47.625" high (lowered height).
- ID fork span range 6" to 19.5".

As shown: RNR-10



Part #	260090	260095	
Model #	RNR-10	RNR-10P	
Lift	6"	6"	
Casters	8" x 2.5" Steel	8" x 3" Urethane	
Weight	480 lbs/PR	475 lbs/PR	

## Options:

### Load Binder Accessory

- Two 12' long nylon belts with heavy duty ratchet tighteners.
- Highly recommended for stabilizing large loads.

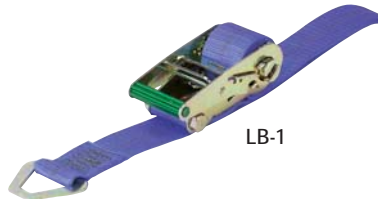

Part #	Model #	
260096	LB-1	Delta rings secure belt to Rais-N-Rol
260147	LB-2	"E" track hooks secure belt to Rais-N-Rol



# Wesco® furniture movers



## Features:

- Sold in pairs only.
- Two models:
  - Manual Lift
  - Hydraulic Lift
- Economically priced.
- Great for moving furniture or odd shaped loads.
- Straps to secure load standard.
- Hydraulic unit with ratcheting strap tightener.



	MANUAL	HYDRAULIC
Part #	272951	272952
Model #	MFM	HFM
Lift Height	12"	10"
Casters	6" Moldon Polyurethane	6" Moldon Polyurethane
Weight	55 lbs	190 lbs
Lift Plate L x D	8 1/2"L x 4 1/2"D	23"L x 2.25"D
Capacity/Pair	1,320 lbs	3,950 lbs
Overall Length	23"	26 1/2"
Width	15"	16"
Height	32"	42"



# Wesco® aluminum platform trucks

## Features:

- Aluminum is corrosion resistant and maintains clean appearance.
- Strong enough to handle up to 3,000 lbs (depending upon caster selection).
- Lightweight aluminum allows for easy maneuverability.
- Corner sockets at both ends allow handles to be used on either or both ends of truck.
- For truck platform height add 2.5" to caster height (see caster option chart).
- Handle included.
- Bolt on casters. (Casters Sold Separately)–choose from caster option chart.



## ATP Series - Aluminum Treadplate Model

### Features:

- Slip-resistant diamond pattern surface.
- Solid one piece platform surface construction.

Platform	24" x 36"	24" x 48"	30" x 48"	30" x 60"	36" x 60"	36" x 72"
Part #	350036	350037	350039	350040	350042	350043
Model #	ATP-2436	ATP-2448	ATP-3048	ATP-3060	ATP-3660	ATP-3672
Weight	32 lbs	40 lbs	45 lbs	54 lbs	61 lbs	71 lbs



## ASD Series - Aluminum Smooth Deck

### Features:

- Smooth surface that is easy to keep clean.
- Solid one piece platform surface construction.

Platform	24" x 36"	24" x 48"	30" x 48"	30" x 60"	36" x 60"	36" x 72"
Part #	350027	350028	350030	350031	350033	350034
Model #	ASD-2436	ASD-2448	ASD-3048	ASD-3060	ASD-3660	ASD-3672
Weight	27 lbs	33 lbs	37 lbs	44 lbs	49 lbs	59 lbs

## Truck Options:

### Corner bumpers

Part # 250022  
Model # CB  
When ordering by model # add CB to truck model #.  
For example: ASD-2436-CB

### Perimeter bumpers

Part # 250023  
Model # PB  
When ordering by model # add PB to truck model #.  
For example: ASD-2436-PB

### Extra push handle

Part numbers are based on truck width and series.  
ATP & ASD series

Truck Width	Part #
24"	052574
30"	052575
36"	052576

When ordering by model # add PH2 to truck model #.  
For example: ASD-2436-PH2

## Caster Options:

- Two rigid, two swivel per set.

Part #	250046	250047	250049	250050	250051	250052	250053	250055	250056	250250
Model #	SR-5A	SR-5	SR-6	MR-6	MP-6	PR-6	MR-8	MP-8	PR-8	PN-8
Wheel Size	5" x 1.5"	5" x 2"	6" x 2"	6" x 2"	6" x 2"	6" x 2"	8" x 2"	8" x 2"	8" x 2"	8" x 2.5"
Wheel Type	Polyolefin	Polyolefin	Polyolefin	Moldon Rubber	Moldon Polyurethane	Phenolic	Moldon Rubber	Moldon Polyurethane	Phenolic	Pneumatic
Capacity	750 lbs	2,000 lbs	2,000 lbs	2,000 lbs	3,000 lbs	3,000 lbs	2,400 lbs	3,000 lbs	3,000 lbs	1,200 lbs
Caster Height	6.375"	6.75"	7.5"	7.5"	7.5"	7.5"	9.5"	9.5"	9.5"	10"
Weight Per Set	14 lbs	20 lbs	26 lbs	26 lbs	24 lbs	26 lbs	28 lbs	27 lbs	30 lbs	29 lbs

# Wesco® steel platform trucks

## Features:

- Heavy duty 12 gauge steel reinforced welded construction.
- Constructed for both standard corner or diamond caster mounting pattern.
- Removable two cross-brace handle can be inserted in either end.
- Eight platform sizes available.
- Choose your caster. Platforms and casters sold separately, except #272265.
- Each caster set contains 2 swivel and 2 rigid casters.
- All platforms include one handle. Additional handles available as an option. (except #272265)
- All listed capacities are based on evenly distributed loads.



## Steel Platform Trucks (Casters sold separately)

Part #	Size L x W	Maximum Platform Capacity	Platform Weight Lbs	Caster
272266	36" x 24"	4,000 lbs.*	54	chart selection
272267	48" x 24"	4,000 lbs.*	65	chart selection
272268	54" x 27"	4,000 lbs.*	82	chart selection
272269	48" x 30"	4,000 lbs.*	115	chart selection
272270	60" x 30"	4,000 lbs.*	132	chart selection
272271	60" x 36"	4,000 lbs.*	111	chart selection
272272	72" x 36"	4,000 lbs.*	127	chart selection

\* Capacity based on evenly distributed loads.

## Caster Sets Actual capacity of assembled truck is dependent upon caster capacity not platform capacity.

Part #	Caster Description	Set Capacity	Weight Lbs
272191	6" x 1.375" Polyolefin	1,600 lbs.	25
272192	8" x 2" Polyolefin	2,500 lbs.	31
272193	8" x 2" Moldon Polyurethane on cast iron hub	4,000 lbs.	38
272194	8" x 2.5" Full Pneumatic	1,600 lbs.	28
272195	10" x 3.5" Full Pneumatic	2,500 lbs.	37
272201	5" x 2" Moldon Rubber on cast iron hub	1,600 lbs.	32
272202	6" x 2" Moldon Rubber on cast iron hub	1,800 lbs.	35
272203	8" x 2" Moldon Rubber on cast iron hub	2,200 lbs.	40

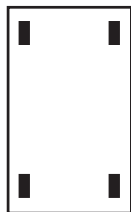

Standard Caster Pattern

OR

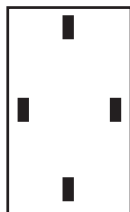

Diamond Caster Pattern

## Extra Handles for Trucks with

	24" Wide Platform	27" Wide Platform	30" Wide Platform	36" Wide Platform
Part #	272197	272198	272199	272200
Weight	15 lbs.	16 lbs.	17 lbs.	19 lbs.



#272265  
Ships complete. Platform, one handle, four 5" x 1.25" casters.

## Economy Steel Platform Truck

Part #	Size L x W	Maximum Platform Capacity	Platform Weight lbs	Caster
272265	42" x 24"	750 lbs.*	74	5" x 1.25" Rubber

\* Capacity based on evenly distributed loads.

# Wesco® wood platform trucks

## Wood Platform Trucks

### Features:

- Two platform styles. Steel bound and wood only.
- Four platform sizes.
- Platform and caster sets sold separately.
- Platforms are dried and varnished hardwood.
- Each platform is shipped complete with one, three cross-brace handle.

Two Styles -  
Four Sizes Per Style



Wood Platform Trucks Part #	Size W x L	Platform Weight	Style Description
172236	24" x 48"	74 lbs.	Steel Bound
172237	27" x 54"	94 lbs.	Steel Bound
172238	30" x 60"	116 lbs.	Steel Bound
172239	36" x 72"	167 lbs.	Steel Bound
172240	24" x 48"	50 lbs.	Wood Only
172241	27" x 54"	64 lbs.	Wood Only
172242	30" x 60"	79 lbs.	Wood Only
172243	36" x 72"	113 lbs.	Wood Only

### Caster Selection

Part #	Size	Description	Weight Lbs	Caster Set Capacity
272201	5" x 2"	Moldon Rubber on Cast Iron Hub	32	1,600 lbs.
272202	6" x 2"	Moldon Rubber on Cast Iron Hub	35	1,800 lbs.
272203	8" x 2"	Moldon Rubber on Cast Iron Hub	40	2,200 lbs.
172244	8" x 2.5"	Full Pneumatic	28	1,200 lbs.
172245	10" x 3.5"	Full Pneumatic	37	1,500 lbs.



Wood Only Style



Steel Bound Style

Capacity of an assembled truck is determined by the caster capacity.

# Wesco® steel service carts

## Service Carts

### Features:

- 5" x 1.25" hard rubber casters.
- 20 gauge steel trays.
- 14 gauge corner posts.
- 3.5" tray depth.
- Baked enamel paint finish.
- 2 sizes, 16" x 30" and 24" x 36".
- Top tray can be inverted for flat work surface.
- Drawer with roller glides for easy operation.
- 500 lb. capacity



SC1630

Part #	270166	270168
Model #	SC1630	SC2436
No. of trays	2	2
Dimensions	16" x 30"	24" x 36"
Weight	34 lbs	44 lbs

500 lb capacity

Look



SC2436 with drawer and 3rd tray option. 3rd tray and drawers are options and sold separate.

### Optional 3rd Tray

Part #	270167	270169
Model #	SCT1630	SCT2436
Dimensions	16" x 30"	24" x 36"
Weight	9 lbs	15 lbs

### Optional Drawer (fits both carts)

Part #	270171
Model #	SCDRW
Dimensions	18.5 d. x 11.75 w. x 3 h.
Weight	8 lbs



# Wesco® Greenline panel carts

## Standard Greenline panel carts

### Features:

- Removable plastic basket for carrying tools.
- Detachable center bar for moving bulky items like tables and partitions.
- Great for sheet products like dry wall and plywood.
- Rollers enable sheet goods to be loaded easily.
- 4" x 2" Phenolic casters 2 swivel/2 rigid with brakes.
- Ships KD.



Part #	272226	272227
Type	Standard	Heavy Duty
Platform Size L x W x H	27" x 32" x 43"	29" x 36" x 34"
Capacity	1,543 lbs	4,400 lbs
Weight	135 lbs	175 lbs



## Heavy Duty Greenline panel carts

### Features:

- Heavy duty steel platform and supports.
- Great for handling heavy sheet products.
- 5" x 2" Moldon polyurethane casters 2 swivel/2 rigid with brakes.
- 12 1/8" spacing between removable vertical supports.
- Ships KD.



# Wesco® folding handle platform trucks

All folding handle platform trucks are UPS shippable.

## Steel Folding Handle Trucks

### Features:

- Fold down handle for easy storage.
- Enameled finish with non-skid heavy vinyl deck surface.
- Protective vinyl perimeter bumpers.



	Deluxe Series	Economy Series
Part #	272019	272238
Platform Size (W x L)	19" x 29"	19" x 29"
Caster Size	4"	4"
Capacity	400 lbs	275 lbs
Weight	25 lbs	27 lbs
Part #	272035	272239
Platform Size (W x L)	23" x 35"	23" x 35"
Caster Size	5"	5"
Capacity	600 lbs	400 lbs
Weight	41 lbs	44 lbs

## Telefolding Aluminum Trucks

### Features:

- Full size platform truck that folds to briefcase size.
- Strong, lightweight aluminum frame.
- Easy rolling 4" dia. rubber casters (2 swivel, 2 rigid).
- Protective vinyl corner bumpers.
- Expandable platform 16" x 20" to 16" x 28".



	Deluxe Series	Economy Series
Part #	272235	
Platform Size (W x L)	23" x 35"	
Caster	8" pneumatic	
Capacity	600 lbs	
Weight	57.5 lbs	

## Professional Series Telefolding Truck

### Features:

- Push button, quick conversion.
- Anti-impact, non-skid polypropylene and aluminum deck.
- Non-marking 4" moldon rubber wheels.
- Sponge rubber coated handle.



	Deluxe Series	Economy Series
Part #	272020	272250
Platform Retracted	16" x 20"	16" x 20"
Platform Extended	16" x 28"	16" x 28"
Capacity	350 lbs	300 lbs
Weight	19 lbs	19 lbs

## Aluminum Folding Handle Truck

### Features:

- Casters: TPR gray rubber.
- Lightweight aluminum deck.
- Wrap around corner bumper.



	Deluxe Series	Economy Series
Part #	272048	
Open Height	37.25"	
Platform Size Retracted	17.5" x 21"	
Platform Size Extended	17.5" x 29.5"	
Capacity	330 lbs	
Weight	16 lbs	

	Deluxe Series	Economy Series
Part #	272076	272112
Platform Size (W x L)	18.5" x 29"	24" x 35.5"
Caster Size	4"	5"
Capacity	330 lbs	330 lbs
Weight	22 lbs	28 lbs

# Wesco® desk mover, office caddy & foldaway tabletop cart

## Desk Mover & Pedestal Adapter

### Features:

- Move a desk without emptying drawers or clearing the top.
- Easy operation, automatically locks in the raised position.
- Vinyl coated lift rack prevents damage and slipping.
- Adjustable pedestal adapter required to move desks with single pedestal.
- Capacity 600 lbs.
- UPS shippable.



Part #	272155
Caster size	2.5"
Lowered height	4.25"
Raised height	9.75"
Handle height	39.5"
Weight	44 lbs

Part #	272156
Caster size	3"
Lowered height	4.75"
Raised height	10.25"
Handle height	40"
Weight	45 lbs

Part #	272157
Caster size	4"
Lowered height	6"
Raised height	11.25"
Handle height	41.25"
Weight	46 lbs

## Office Caddy

### Features:

- Multi-purpose service truck ideal for offices, and service vehicles.
- Fits in most car trunks.
- Easily converts for use as a four wheel rolling table or two or four wheel hand truck. 7 possible positions.
- 19" x 23.5" oak color top with vinyl edge.
- 8" x 1.75" easy roll semi-pneumatic wheels and 2.5" hard rubber swivel casters.
- UPS shippable.



Part #	272079
Capacity as 2 wheel truck	200 lbs
Capacity as 4 wheel truck	400 lbs
Capacity as 4 wheel table	100 lbs
Weight	50 lbs

## Foldaway Table Top Cart

### Features:

- Folds for easy storage.
- Ideal for transporting instruments and office equipment.
- Laminate surface with vinyl edge.
- Four 4" swivel ball bearing casters.
- 1" diameter, 18 gauge plated tubular construction.
- UPS shippable.



Part #	272233
Lower basket (L x W)	21" x 13"
Overall size (L x W x H)	28" x 19" x 28.75"
Table Top size (L x W)	28" x 19"
Capacity	200 lbs
Weight	35 lbs



# Wesco® lightweight folding trucks

## Mega Mover, Maxi Mover, Superlite & Mini Mover Folding Trucks

### Features:

- U.S. patent no. 411,679.
- Space saving folding design. Fits into small storage spaces or car trunks.
- Elastic straps for securing load.
- Aluminum or steel construction.
- Non-marking, shock absorbing, rubber tread tires.
- Mini Mover fits into overhead air-line compartments.

Size Comparison



Easy push button operation for quick set up. Pull down the noseplate and the wheels move into working position.



LOOK →

	Mini Mover	Superlite	Maxi Mover	Mega Mover
Part #	220646	220617	220649	220650
Wheel size	5" x 1.25"	7" x 1.5"	7" x 1.5"	8" x 2.5"
Extended Height	41"	42"	42"	47"
Extended Width	15.5"	19"	19"	26.5"
Extended Depth	17.5"	19"	19"	25.5"
Folded Height	24"	29.5"	29.5"	34"
Folded Width	15.25"	19"	19"	23.5"
Folded Depth	2"	2"	2"	4.75"
Noseplate dimensions	15" w x 12.5" d	19" w x 12" d	19" w x 12" d	23.5" w x 18" d
Capacity	110 lbs	175 lbs	250 lbs	550 lbs
Weight	7.25 lbs	8.4 lbs	12 lbs	28.5 lbs.
Construction	Aluminum	Aluminum	Steel	Aluminum

# Wesco® wire office carts

## Wire Office Carts

### Features:

- Ideal for carrying hanging files (letter and legal) mail, packages and tools.
- Removable baskets.
- 1" diameter, 18 gauge tubular construction.
- All metal surfaces plated for long life.
- Shipped KD.
- UPS shippable.



	Standard Compact Office Cart 272228	Deluxe Compact Office Cart 272230	Deluxe Large Office Cart 272231
Part #	272228	272230	272231
Upper basket (L x W x D)	25" x 17.25" x 11"	25" x 17.25" x 11"	36" x 17.25" x 11"
Lower basket (L x W x D)	25" x 17.25" x 7.5"	25" x 17.25" x 7.5"	36" x 17.25" x 7.5"
Overall size (L x W x H)	33" x 20" x 37.5"	33.5" x 23.75" x 38.25"	43" x 23.75" x 38.5"
Front wheels	4" hard rubber casters	5" hard rubber casters	5" hard rubber casters
Rear wheels	4" hard rubber casters	10" semi-pneumatic	10" semi-pneumatic
Capacity	200 lbs	200 lbs	250 lbs
Weight	32 lbs	41 lbs	62 lbs



# Wesco® steel deck machine dolly & HeviMover™

## Steel Deck Machine Dolly

### Features:

- 10,000 lb capacity.
- 11.75" l x 8.5" w x 2.5" high.
- .25" thick steel plate.
- 2" x .5" aircraft quality, heat treated steel wheels.
- Weight: 10 lbs.



# 480020

## HeviMover™ Machine Rollers

### Features:

- Swivel-top for maximum maneuverability, full 360° rotation.
- Spring-loaded locking mechanism at 45° intervals.
- Only periodic cleaning and light re-oiling of roller chain needed.

HMS-8



HeviMovers™ are made with precision ground and hardened steel rollers that form an endless chain which revolves around a central load-bearing plate in the frame. Weight of the load is transferred directly from load-bearing plate to rollers. This eliminates axle friction and requires less power to start and move the load. HeviMovers™ roll easily over cracks and pitted floor areas to reduce possible damage to goods.

Part #	480001	480002	480003	480004
Model #	HMS-2	HMS-8	HMS-15	HMS-30
Body (H x W x L)	3.1875" x 3.125" x 8"	4.4375" x 5.5" x 10"	4.875" x 5.75" x 10.5"	4.875" x 6.5" x 12.75"
Roll Width	1.875"	3.25"	3.25"	4"
Roll Diameter	.6875"	.9375"	1.1875"	1.1875"
Capacity (each)	2,000 lbs	8,000 lbs	15,000 lbs	30,000 lbs
Weight	10 lbs	31 lbs	39 lbs	52 lbs

## HeviMover™ Kit

### Features:

- Includes 4 HMS-2 HeviMovers and 2 29" knocked down steering handles in a rugged steel tool box.



HMS-2K  
480019

## HeviMover™ Options

- Steering handles.
- Turning bar.

	Model #	Part #	Weight
36" steering handle for HMS-2	HMH-36-1	480005	6 lbs
48" steering handle for HMS-2	HMH-48-1	480006	7 lbs
36" steering handle for HMS-8, 15, 30	HMH-36-2	480007	6 lbs
48" steering handle for HMS-8, 15, 30	HMH-48-2	480008	7 lbs
36" turning bar for HMS-8, 15, 30	HMH-TB-2	480009	14.5 lbs

# Wesco® plastic box trucks

## Features:

- Useful for storing, protecting and transporting bulky, heavy material.
- One-piece seamless molded construction assures long service life.
- Easy-to-clean molded polyethylene.
- Can ship knocked down and nested on quantity orders.

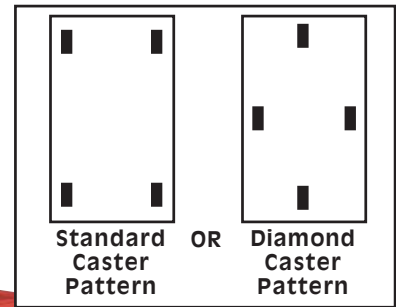

## Plastic Box Trucks

### Features:

- Five sizes and color choices (white, grey, blue, red, yellow).
- Casters mounted on 5-ply plywood base for extra rigidity (except 4 bushel models).
- Two swivel, two rigid 5" polyurethane casters.
- Heavy 0.125" wall thickness.
- Caster pattern Standard or Diamond



Capacity	32 gal. 4 bushels 350 lbs	64 gal. 8 bushels 450 lbs	96 gal. 12 bushels 550 lbs	128 gal. 16 bushels 600 lbs	160 gal. 20 bushels 600 lbs
Outside H x W x L	21.5" x 21" x 32"	30" x 24" x 35.5"	35" x 28" x 38"	37" x 30" x 42"	40" x 34" x 46"
Weight	19 lbs	32 lbs	37 lbs	41 lbs	54 lbs
Grey Part #	272503	272508	272513	272518	272523
Blue Part #	272504	272509	272514	272519	272524
White Part #	272505	272510	272515	272520	272525
Red Part #	272506	272511	272516	272521	272526
Yellow Part #	272507	272512	272517	272522	272527

To order the diamond caster pattern, add DP to Part #. Example: 272513DP.

# Wesco® wood dollies

## Wood Dollies

### Features:

- 4 swivel casters.
- Seasoned hardwood with flush top bolted construction.
- Optional tow handle and eye hook.
- Capacity:  
3" hard rubber casters—900 lbs.  
4" hard plastic casters—1200 lbs.
- Ships KD boxed.

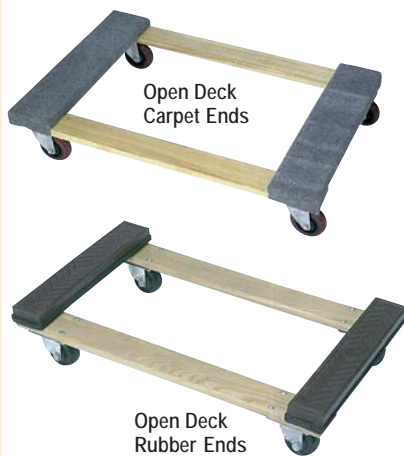

Description	Size	Part # 3" Casters (Weight)	Part # 4" Casters (Weight)
Solid platform	24" x 16"	272053 (13 lbs)	272063 (13 lbs)
	27" x 18"	272054 (14 lbs)	272064 (14 lbs)
	30" x 18"	272055 (14 lbs)	272065 (15 lbs)
	36" x 24"	272056 (16 lbs)	272066 (16 lbs)
Flush open deck	24" x 16"	272057 (10 lbs)	272067 (10 lbs)
	30" x 18"	272058 (11 lbs)	272068 (11 lbs)
	36" x 24"	272059 (11 lbs)	272069 (12 lbs)
Open deck carpet ends	30" x 18"	272060 (11 lbs)	272070 (11 lbs)
	36" x 24"	272061 (12 lbs)	272071 (12 lbs)
Open deck rubber ends	30" x 18"	272062 (13 lbs)	272072 (11 lbs)

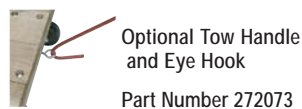

# Wesco® strapping trucks and tools

## Universal Strapping Truck

### Features:

- Automatic brake to reduce strap spillage.
- Tray for storing tools and seals.
- Handles steel and non-metallic strapping.
- Accepts 3", 6" and 8" face coils; 8" and 16" core sizes.
- Heavy duty tubular frame.
- UPS shippable.



272286

Hub:	Steel
Dimensions:	10" x 1.75"
Wheel Type:	Semi-Pneumatic
Part #	272286
Weight	54 lbs

## Poly Strapping System

### Features:

- Tools for tightening and sealing poly and plastic strap.
- High quality tensioner tightens and cuts .5" to .625" plastic strap.



272008



272009

Part #	Description	Size
272008	Tensioner	.5" to .625"
272009	Sealer	.5" only
272010	Sealer	.625" only

## Steel Strapping System

### Features:

- Tools for tightening and sealing steel banding.
- Cast steel tensioner for most sizes (.375" to .75").



272011



272024

Part #	Description	Size
272011	Tensioner	.375" to .75"
272023	Sealer	.375" only
272024	Sealer	.5" only
272025	Sealer	.75" only

## Strap Cutters

### Features:

- Spring loaded for one hand operation.



Part #	Description	Size
272015	Deluxe	Up to .75"

## Tensioner/Crimper

### Features:

- Push/windless type for steel strapping.
- With cutter and hammer knob for seal closing.
- For use with wing seals.
- Use for on .375" - .75" wide and up to .030" thick steel strap.



Part #	Description	Size
272022	Tensioner/Crimper	.375" to .75"

# Wesco® easy mount strip doors

## Easy Mount Strip Doors

### Features:

- Molded plastic, high-strength, patented Easy-Mount Bracket. No bolts or screws, just hook it on.
- Energy conserving.
- Reduces noise, dirt, dust and odors. Helps meet OSHA noise rules.
- Two-way visibility.
- No wasted space for swinging door.
- High quality flexible vinyl.
- Functional from -20° to 150° F as an effective thermal barrier. Special compound reduces bruising and lacerations and fading UV rays.
- Two styles:  
**Smooth** – concave/convex overlap for best seal in 12" and 8" widths.  
**Ribbed** – reduced scratching and improved sealing.
- Orange end panels on doors with 12" strips.
- 12" strips are .120 thick; 8" strips are .080" thick.
- Can be ordered as complete doors, individual strips, and bulk lengths.
- Custom sizes available.
- Note: The length of the strip is dependent on the type of mount used.



Inside Mount

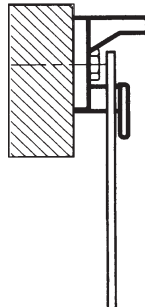
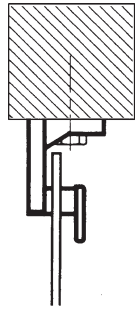

Surface (wall) Mount



Ribbed Strip



Smooth Strip

### Heavy Duty – 12" strip width 66% overlap

Opening W.x H.	Smooth Part #	Ribbed Part #
6' x 7'	272813	272863
6' x 8'	272814	272864
6' x 9'	272815	272865
6' x 10'	272816	272866
6' x 12'	272817	272867
7' x 7'	272818	272868
7' x 8'	272819	272869
7' x 9'	272820	272870
7' x 10'	272821	272871
7' x 12'	272822	272872
8' x 7'	272823	272873
8' x 8'	272824	272874
8' x 9'	272825	272875
8' x 10'	272826	272876
8' x 12'	272827	272877
9' x 7'	272828	272878
9' x 8'	272829	272879
9' x 9'	272830	272880
9' x 10'	272831	272881
9' x 12'	272832	272882
10' x 7'	272833	272883
10' x 8'	272834	272884
10' x 9'	272835	272885
10' x 10'	272836	272886
10' x 12'	272837	272887
12' x 7'	272838	272888
12' x 8'	272839	272889
12' x 9'	272840	272890
12' x 10'	272841	272891
12' x 12'	272842	272892
14' x 7'	272843	272893
14' x 8'	272844	272894
14' x 9'	272845	272895
14' x 10'	272846	272896
14' x 12'	272847	272897

### Walk Through Doors – 8" strip width 50% overlap

Opening W.x H.	Smooth Part #	Ribbed Part #
3' x 7'	272801	N/A
3' x 8'	272802	N/A
4' x 7'	272803	N/A
4' x 8'	272804	N/A
5' x 7'	272805	N/A
5' x 8'	272806	N/A
6' x 7'	272807	N/A
6' x 8'	272808	N/A
7' x 7'	272809	N/A
7' x 8'	272810	N/A
8' x 7'	272811	N/A
8' x 8'	272812	N/A

Replacement Strips – Clear		
Size	Smooth Part #	Ribbed Part #
8' x 7'	171001	N/A
8' x 8'	171002	N/A
12' x 7'	171003	171012
12' x 8'	171004	171013
12' x 9'	171005	171014
12' x 10'	171006	171015
12' x 12'	171007	171016

Replacement Strips – Orange		
Size	Smooth Part #	Ribbed Part #
12' x 7'	171022	171032
12' x 8'	171023	171033
12' x 9'	171024	171034
12' x 10'	171025	171035
12' x 12'	171026	171036

Bulk Strip – Order by the foot		
Color/Width	Smooth Part #	Ribbed Part #
Clear 8'	172003	N/A
Clear 12'	172004	172006
Orange 12'	172005	172007

Replacement Hangers	
Length	Part #
24"	172001

■ Note: Models and sizes shown are for inside mount. For outside or surface mount select next highest width and height or select size as required.



# Wesco® dock lights, pallet pullers & curb ramps

## Dock Lights and Fan

### Features:

- Heavy duty steel construction.
- Durable yellow enamel and brass-plated finish.
- Spring-loaded pushup socket for easy bulb changing.
- 7 gauge wall mount standard.
- 18" two speed  approved fan accessory.
- Use with incandescent lamps only: PAR-38: up to 150W R40: up to 300W.



### Lights

Part #	Length	Weight
272224	24"	13.5 lbs
272240	40"	15.5 lbs
272260	60"	17.8 lbs
272290	90"	15.5 lbs

### Fans

Part #	Description	Weight
272330	Fan only	19 lbs
272328	Fan with 40" arm	32 lbs
272329	Fan with 60" arm	37 lbs

## Pallet Pullers

### Features:

- Rugged cast iron construction.
- One-piece curved heads have integral spurs to bite into stringers up to 4.5" thick.
- Self-cleaning heads are unaffected by wood particles, paint or grease.
- Non-load rated. Recommended working load limit is 1,250 lbs. for .25" proof coil chain.
- PUL-LP & PUL-M2 are low profile (1.75" high when grabbing stringer)
- PUL-2 is a standard head (2.75" high when grabbing stringer).

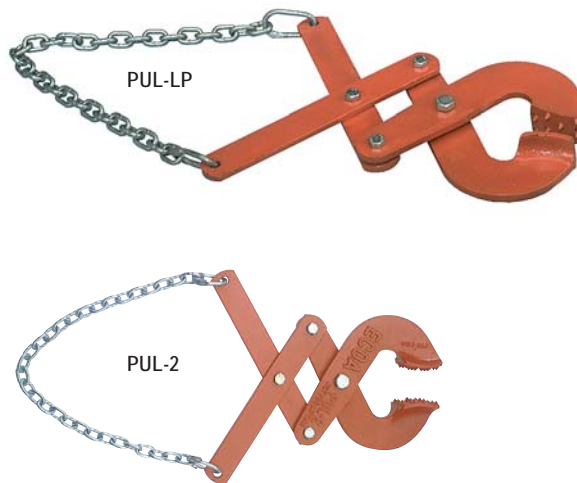

	4.5" Jaw Opening	5.5" Jaw Opening
Part #	272021	470008
Model #	PUL-LP	PUL-M2
Jaw Height	1.75"	1.75"
Chain Length/Proof	30"/.25"	12"/.25"
Weight	19 lbs	12.5 lbs
Part #	470007	
Model #	PUL-2	
Jaw Height	2.75"	
Chain Length/Proof	30"/.25"	
Weight	20 lbs	

## Curb Ramp

### Features:

- Lightweight, portable ramp allows for easy movement up and down curbs.



23.5" l. x 21.5" w. x 6" h.

	Yellow Generic	Red Coca Cola®	Blue Pepsi®
Part #	150800	150801	150802
Capacity	600 lbs	600 lbs	600 lbs
Weight	7 lbs	7 lbs	7 lbs

# Wesco® chrome-plated wire shelving

## Features:

- Open wire design that provides maximum visibility and air circulation while minimizing dust accumulation.
- All units are NSF® Approved for use in the food industry.
- Sets up easily without tools.
- Shelves adjust at 1" increments on numbered posts.
- Adjustable floor levelers compensate for surface irregularities.
- Begin with "starter" units and then "add-on" additional units.
- Not suitable for refrigerated or freezer cold storage environments.

## Wire Shelving Starter Unit

### Features:

- Kit consists of 4 posts, 4 shelves and 16 post sleeves that secure shelves to posts.
- Posts are numbered around diameter in 1" increments.
- 24 sizes to choose from: shelves available in 18" and 24" depth and 48", 60", and 72" length; posts are available in 63", 74", and 86" heights.



## Add-On Kit

### Features:

- Kit consists of 2 posts, 4 shelves, 8 "S" hooks and 8 post sleeves that secure shelves to posts.
- "S" hooks attach Add-on Kits to existing shelving units.
- 24 sizes to choose from: shelves available in 18" and 24" depth, and 48", 60", and 72" length; posts are available in 63", 74", and 86" heights.



## STARTER UNITS

Part #	Size (D x W x H)	Total Unit Capacity*	Capacity Per Shelf*
272640	18" x 36" x 63"	2,400 lbs	600 lbs
272641	18" x 36" x 74"	2,400 lbs	600 lbs
272642	18" x 36" x 86"	2,400 lbs	600 lbs
272703	18" x 48" x 63"	2,400 lbs	600 lbs
272704	18" x 48" x 74"	2,400 lbs	600 lbs
272705	18" x 48" x 86"	2,400 lbs	600 lbs
272706	18" x 60" x 63"	2,400 lbs	600 lbs
272707	18" x 60" x 74"	2,400 lbs	600 lbs
272708	18" x 60" x 86"	2,400 lbs	600 lbs
272709	18" x 72" x 63"	2,000 lbs	500 lbs
272710	18" x 72" x 74"	2,000 lbs	500 lbs
272711	18" x 72" x 86"	2,000 lbs	500 lbs
272643	24" x 36" x 63"	2,400 lbs	600 lbs
272644	24" x 36" x 74"	2,400 lbs	600 lbs
272645	24" x 36" x 86"	2,400 lbs	600 lbs
272712	24" x 48" x 63"	2,400 lbs	600 lbs
272713	24" x 48" x 74"	2,400 lbs	600 lbs
272714	24" x 48" x 86"	2,400 lbs	600 lbs
272715	24" x 60" x 63"	2,400 lbs	600 lbs
272716	24" x 60" x 74"	2,400 lbs	600 lbs
272717	24" x 60" x 86"	2,400 lbs	600 lbs
272718	24" x 72" x 63"	2,000 lbs	500 lbs
272719	24" x 72" x 74"	2,000 lbs	500 lbs
272720	24" x 72" x 86"	2,000 lbs	500 lbs

\*Capacity in pounds based on evenly distributed loads.

## ADD-ON KITS

Part #	Size (D x W x H)	Total Unit Capacity*	Capacity Per Shelf*
272646	18" x 36" x 63"	2,400 lbs	600 lbs
272647	18" x 36" x 74"	2,400 lbs	600 lbs
272648	18" x 36" x 86"	2,400 lbs	600 lbs
272721	18" x 48" x 63"	2,400 lbs	600 lbs
272722	18" x 48" x 74"	2,400 lbs	600 lbs
272723	18" x 48" x 86"	2,400 lbs	600 lbs
272724	18" x 60" x 63"	2,400 lbs	600 lbs
272725	18" x 60" x 74"	2,400 lbs	600 lbs
272726	18" x 60" x 86"	2,400 lbs	600 lbs
272727	18" x 72" x 63"	2,000 lbs	500 lbs
272728	18" x 72" x 74"	2,000 lbs	500 lbs
272729	18" x 72" x 86"	2,000 lbs	500 lbs
272649	24" x 36" x 63"	2,400 lbs	600 lbs
272650	24" x 36" x 74"	2,400 lbs	600 lbs
272651	24" x 36" x 86"	2,400 lbs	600 lbs
272730	24" x 48" x 63"	2,400 lbs	600 lbs
272731	24" x 48" x 74"	2,400 lbs	600 lbs
272732	24" x 48" x 86"	2,400 lbs	600 lbs
272733	24" x 60" x 63"	2,400 lbs	600 lbs
272734	24" x 60" x 74"	2,400 lbs	600 lbs
272735	24" x 60" x 86"	2,400 lbs	600 lbs
272737	24" x 72" x 63"	2,000 lbs	500 lbs
272738	24" x 72" x 74"	2,000 lbs	500 lbs
272739	24" x 72" x 86"	2,000 lbs	500 lbs

\*Capacity in pounds based on evenly distributed loads.

# Wesco® chrome-plated wire shelving

## Accessories for Wire Shelving

### Features:

- 5" x 1.25" stem casters. Choice of polyurethane or rubber wheels.
- Foot plates to bolt racks to the floor.
- Shelf edges to prevent items from falling.
- Extra shelves sold in pairs only.
- Leveling feet protect flooring and level racks on uneven surfaces.
- Post clamps join units together and "S" hooks are needed when adding shelves.
- Snap in 8" high shelf dividers keep shelves organized.
- Replacement posts sold in pairs only.

Shelf edges

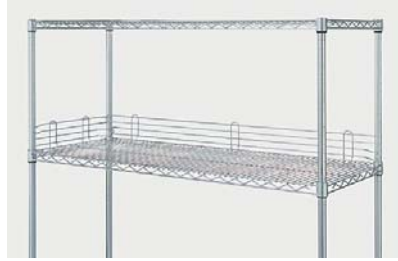

Shelf dividers



Extra shelves

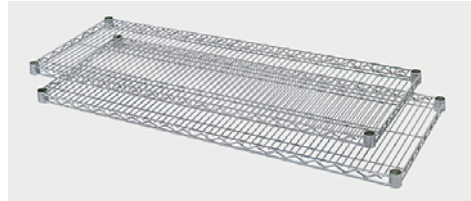

Posts



Caster sets



Part #	Description
<b>Shelf Edges</b>	
170247	18" shelf edge
170248	24" shelf edge
170273	36" shelf edge
170249	48" shelf edge
170251	60" shelf edge
170252	72" shelf edge
<b>Shelf Dividers</b>	
170253	18" shelf divider
170254	24" shelf divider
<b>Shelf Sets</b>	
170278	Two 18" x 36" shelves
170264	Two 18" x 48" shelves
170265	Two 18" x 60" shelves
170266	Two 18" x 72" shelves
170279	Two 24" x 36" shelves
170267	Two 24" x 48" shelves
170268	Two 24" x 60" shelves
170269	Two 24" x 72" shelves
<b>Shelf Posts</b>	
170261	Two 63" posts
170262	Two 74" posts
170263	Two 86" posts
<b>Caster Sets</b>	
170258	Rubber caster set (4 per set, 2 with brakes, 2 without)
170270	Polyurethane caster set (4 per set, 2 with brakes, 2 without)
<b>Other Components</b>	
170256	Leveling feet
170255	"S" hooks
170260	Post clamps
170257	Foot plates
170259	Replacement post sleeves



Leveling feet



"S" hooks & Clamps



Foot plates



Replacement sleeves



# Wesco® trailer stabilizing jacks & cargo bars

Wesco recommends always using at least two jacks per trailer.  
Meets OSHA requirements.

## Trailer stabilizing jacks

### Features:

- High strength steel construction.
- Adjustable height for leveling of trailers parked on uneven ground.
- Broad base prevents trailer dollies from sinking into soft surfaces.
- Prevents up-ending of semi-trailers when not connected to a truck during loading/unloading.
- Meets OSHA requirements.
- Three models, economy, standard and heavy duty.



	ECONOMY	STANDARD	HEAVY DUTY
Part #	272957	272955	272956
Model #	TSJE	TSJS	TSJHD
Static Capacity	50,000 lbs	100,000 lbs	100,000 lbs
Lifting Capacity	5,000 lbs	40,000 lbs	50,000 lbs
Service Range	44" - 51"	39 1/2" x 51"	39 1/2" x 51"
Weight	45 lbs	125 lbs	160 lbs

**TSJE Economy**, manually turned ACME threaded screw raises and lowers jack. 14" dia. base, 5" x 5" top plate.  
**TSJS Standard**, ratchet with ACME threaded screw raises and lowers jack. 14" diameter x 1/2" thick base plate, 8" semi-pneumatic wheels. 8" diameter top plate.  
**TSJHD Heavy duty**, two way reversible hand ratchet, 6" x 24" long beam, 15" triangular base, 8" semi-pneumatic wheels, and 4" semi-steel wheels.

## Cargo bars and hoops

### Features:

- Helps secure loads to prevent shifting.
- One or two piece construction.
- Materials of construction are lightweight aluminum and heavy duty steel.
- Four models.
- Optional hoops available.



Part No.	Model No.	Weight	Length Adjustment	Articulating Foot Pads
272958	CBA1000	9 lbs	87" - 103"	4" x 2 1/2"
272959	CBS2000	18 lbs	87" - 115"	4" x 4"
272960	CBGS3000	26 lbs	64" - 130"	4" x 4"
272961	CBS4000	16 lbs	82 1/2" - 110"	4" x 4"
272962	CBHOOP	15 lbs	NA	NA



## CAREFREE WHEEL *Microcellular Polyurethane – will not go flat*



CF

PART NO.	MODEL	DIAMETER	HUB TYPE	TREAD WIDTH	HUB LENGTH	BORE ID	APPROX. WEIGHT	BEARING TYPE	CAPACITY LBS.
053446	CF	10"	Steel	3"	2.25"	.625"	5 LBS.	BALL	280
053490	CFB	10"	Steel	3"	2.25"	.75"	5 LBS.	BALL	280

## SOLID RUBBER WHEELS



Z2

PART NO.	MODEL	DIAMETER	HUB TYPE	TREAD WIDTH	HUB LENGTH	BORE ID	APPROX. WEIGHT	BEARING TYPE	CAPACITY LBS.
150698	Z2	10"	Poly	2.75"	2.25"	.625"	5 LBS. 12 OZ.	BALL	550
150697	Z8	8"	Poly	2.0"	2.25"	.625"	3.5 LBS.	BALL	300
150699	Z6	6"	Rubber	2.0"	2.25"	.625"	3 LBS.	NONE	350
108479	SR	10"	Poly	2.5"	2.25"	.625"	9 LBS.	BALL	250

## SEMI-PNEUMATIC WHEELS



Z

PART NO.	MODEL	DIAMETER	HUB TYPE	TREAD WIDTH	HUB LENGTH	BORE ID	APPROX. WEIGHT	BEARING TYPE	CAPACITY LBS.
150225	Q	8"	Poly	1.75"	2"	.625"	3 LBS.	PLAIN	150
050578	R1	8"	Zinc/Steel	2.5"	2"	.625"	4.25 LBS.	BALL	250
052859	R1B	8"	Zinc/Steel	2.5"	2"	.75"	4.25 LBS.	BALL	250
150589	Z	10"	Zinc/Steel	2.75"	2.25"	.625"	6.25 LBS.	BALL	350
052862	ZB	10"	Zinc/Steel	2.75"	2.25"	.75"	6.25 LBS.	BALL	350

## PNEUMATIC WHEELS



P

PART NO.	MODEL	DIAMETER	HUB TYPE	TREAD WIDTH	HUB LENGTH	BORE ID	APPROX. WEIGHT	BEARING TYPE	CAPACITY LBS.
050602	P	10"	Zinc/Steel	3.50"	2.25"	.625"	4 LBS.	BALL	350
108478	PB	10"	Zinc/Steel	3.50"	2.25"	.75"	4 LBS.	BALL	350
108484	P-12	12"	Zinc/Steel	4"	3.25"	.75"	7 LBS.	BALL	350
151507**	PWT	10"	Zinc/Steel	3.50"	2.25"	.625"	4 LBS.	BALL	350
151505	PE	10"	Zinc/Steel	3.50"	2.25"	.625"	3 LBS.	BALL	350

\*\* Actual tread face wider than indicated tread width.

## ALUMINUM CENTER MOLDON RUBBER WHEELS



R

Typical aluminum center moldon wheel



R3

PART NO.	MODEL	DIAMETER	HUB TYPE	TREAD WIDTH	HUB LENGTH	BORE ID	APPROX. WEIGHT	BEARING TYPE	CAPACITY LBS.
050567	A	6"	Solid	2"	2.375"	.625"	2.5 LBS.	BALL	500
052776	AB	6"	Solid	2"	2.375"	.75"	2.5 LBS.	BALL	500
053706	-	6"	Solid	2"	2.1875"	.625"	2.5 LBS.	ROLLER	500
053707	-	6"	Solid	2"	2.1875"	.75"	2.5 LBS.	ROLLER	500
052870	RB	8"	Solid	1.625"	2"	.75"	3 LBS.	BALL	500
108545	R	8"	Solid	1.625"	2"	.625"	3 LBS.	BALL	500
052868	H-1B	8"	Solid	2"	2.25"	.75"	3.75 LBS.	BALL	550
053708	H-1R	8"	Solid	2"	2.1875"	.625"	3.75 LBS.	ROLLER	600
150131	H-1RB	8"	Solid	2"	2.1875"	.75"	3.75 LBS.	ROLLER	600
108546	RK-10	10"	Solid	2"	2.25"	.625"	4.5 LBS.	BALL	600
108561	R3	8"	Spoke	1.625"	1.625"	.625"	2.5 LBS.	BALL	300

## BALLOON CUSHION WHEELS



PART NO.	MODEL	DIAMETER	TREAD WIDTH	HUB LENGTH	BORE ID	APPROX. WEIGHT	BEARING TYPE	CAPACITY LBS.
150228	BC-10	10"	2.165"	2.25"	.625"	4 LBS. 12 OZ.	BALL	300
150229	BC-8	8"	2.165"	2.25"	.625"	2 LBS. 12 OZ.	BALL	300
050566	RK8B	8"	2.25"	2.25"	.750"	3 LBS. 10 OZ.	BALL	450

## CAST IRON CENTER MOLDON RUBBER WHEELS



PART NO.	MODEL	DIAMETER	TREAD WIDTH	HUB LENGTH	BORE ID	APPROX. WEIGHT	BEARING TYPE	CAPACITY LBS.
053722	-	5"	2"	2.1875"	.75"	3.25 LBS.	ROLLER	500
108838	-	6"	1.5"	2"	.75"	3.50 LBS.	BALL	400
108839	-	6"	1.5"	2"	.625"	3.50 LBS.	BALL	400
053723	-	6"	2"	2.1875"	.625"	4.25 LBS.	ROLLER	500
053724	-	6"	2"	2.1875"	.75"	4.25 LBS.	ROLLER	500
050579	H	8"	2"	2.1875"	.625"	6.25 LBS.	ROLLER	600
150120	HB	8"	2"	2.1875"	.75"	6.25 LBS.	ROLLER	600
150596	BT	10"	2.5"	2.75"	1.00"	13.75 LBS.	ROLLER	800

## POLYOLEFIN CENTER MOLDON RUBBER WHEEL



PART NO.	MODEL	DIAMETER	TREAD WIDTH	HUB LENGTH	BORE ID	APPROX. WEIGHT	BEARING TYPE	CAPACITY LBS.
150692	R2	8"	1.625"	2.187"	.625"	1 LB.	PLAIN	375

## SOLID POLYOLEFIN WHEELS



PART NO.	MODEL	DIAMETER	TREAD WIDTH	HUB LENGTH	BORE ID	APPROX. WEIGHT	BEARING TYPE	CAPACITY LBS.
150103	CWP-1	2.5"	1.125"	1.25"	.5"	2.5 OZ.	PLAIN	200
150197	-	3"	1.25"	1.56"	.375"	3 OZ.	PLAIN	300
101355	-	4"	1.25"	1.56"	.5"	5 OZ.	PLAIN	350
108300	CT-3	5"	1.5"	1.62"	.5"	8 OZ.	PLAIN	400
150693	E-2	6"	1.5"	1.625"	.625"	13 OZ.	PLAIN	500
150204	-	8"	2"	2.25"	.75"	2 LBS.	PLAIN	600
150691	BT-W	10"	2"	2.75"	1.00"	2.5 LBS.	PLAIN	750

## PHENOLIC RESIN WHEELS



PART NO.	MODEL	DIAMETER	TREAD WIDTH	HUB LENGTH	BORE ID	APPROX. WEIGHT	BEARING TYPE	CAPACITY LBS.
053902	-	5"	2"	2.1875"	.625"	1.75 LBS.	ROLLER	1000
053769	-	5"	2"	2.1875"	.75"	1.75 LBS.	ROLLER	1000
053903	-	6"	2"	2.1875"	.625"	2.5 LBS.	ROLLER	1200
053770	-	6"	2"	2.1875"	.75"	2.5 LBS.	ROLLER	1200

WESCO® Industrial Products, Inc.

